

***ENGLISH***

**PS-800-12080  
INSTRUCTION MANUAL**

# CONTENTS

<b>1. SPECIFICATIONS .....</b>	<b>1</b>
<b>2. CONFIGURATION .....</b>	<b>2</b>
<b>3. INSTALLATION.....</b>	<b>3</b>
3-1. Setting up the sewing machine .....	3
3-1-1. Unpacking .....	3
3-1-2. Setting up the X feed mechanism and the table.....	5
3-1-3. Setting up the table .....	6
3-1-4. Setting up the switches, bobbin winder and switch button (asm.) .....	7
3-1-5. Check points and precautions before turning the power ON .....	8
3-2. Installing the air hose .....	9
3-3. Cautions for the compressed air supply (source of supply air) facility .....	10
3-4. Installing the bobbin winder device .....	11
3-5. Winding the bobbin thread.....	11
3-6. Precautions for installation of the machine .....	12
<b>4. PREPARATION OF THE SEWING MACHINE .....</b>	<b>13</b>
4-1. Lubricating method and check of the oil quantity .....	13
4-2. Attaching the needle.....	14
4-3. Threading the machine head .....	15
4-4. Bobbin replacement procedure .....	16
4-5. Adjusting the thread tension .....	17
4-6. Adjusting the thread take-up spring and the thread breakage detector plate .....	18
4-7. Adjusting the thread take-up stroke.....	18
4-8. Needle-to-hook relationship .....	19
4-9. How to wind a bobbin.....	21
4-10. Adjusting the position of the thread trimmer.....	22
4-11. How to attach / remove the cylinder lifting plate .....	24
4-12. How to confirm the amount of oil (oil splashes) in the hook.....	25
4-13. Adjusting the amount of oil in the hook .....	26
4-14. Adjusting the needle hole in the throat plate and the needle.....	27
4-15. Setting the mechanical origin.....	28
4-16. Adjusting the disk presser pressure.....	29
4-17. Adjusting the thread end position at the beginning of sewing .....	30
4-18. Adjusting the electronic intermediate presser stroke.....	31
4-19. Adjusting the air blow for the needle thread and bobbin thread .....	32

4-20. Making a template.....	33
4-21. Preparation for sewing.....	35
4-22. RFID (How to use the IC tag).....	37
4-23. Configuration of the operation panel.....	39
4-24. Maintenance mode.....	41
4-25. List of parameters.....	42
4-26. List of error codes .....	48
<b>5. MAINTENANCE OF SAWING MACHINE .....</b>	<b>64</b>
5-1. Troubles and corrective measures (Sewing conditions) .....	69
5-2. Disposal of batteries.....	71
<b>6. SUBCLASS MODEL.....</b>	<b>72</b>
6-1. Barcode reader.....	72
6-2. Rotary knife .....	77
6-2-1. Safety precautions .....	77
6-2-2. How to carry out coaxial adjustment.....	78
6-2-3 How to adjust the timing belt tension .....	81
6-2-4 How to adjust he knife pressure .....	81
6-2-5. Changing the moving knife .....	85
6-2-6. Adjusting the operating speed of template when the knife operates.....	85
6-2-7. Usage instructions .....	86
6-2-8. Definition of the electrical control buttons .....	88
6-2-9. Function-related precautions .....	88

# 1. SPECIFICATIONS

1	Sewing area (X,Y)(mm)	1200 × 800 (Cutting area Rotary knife type : 698 × 391 Laser type : 646.5 × 426.5)
2	Feed motion of feeding frame	Intermittent feed (2-shaft drive by stepping motor)
3	Needle bar stroke	39.5 mm
4	Max. sewing speed	[S type] 3,000 sti/min (When stitching pitch is 2.2 mm or less) [H type] 1,800 sti/min (When stitching pitch is 3.5 mm or less) For other stitch pitches and numbers of revolutions, refer to Fig. 1.
5	Settable stitch length	0.5 to 12.7 mm
6	Needle	[S type] DB × 1 #8 (#7 to #14), DP × 5 #8 (#7 to #14) [H type] DP17 #21 To be chosen according to the model.
7	Hook	Double-capacity full-rotary hook
8	Intermediate presser stroke	4 mm (Standard)
9	Lift of intermediate presser	20 mm
10	Lift of disc presser	15 mm
11	Memory of pattern data	Max. 999 patterns
12	Number of patterns that can be identified	Max. 999 patterns
13	Program input method	USB
14	Data format	DXF.AI.PLT.DST
15	Main shaft servomotor power	[S type] 550W [H type] 750W
16	Power consumption	470VA
17	Input voltage	220V ± 10%
18	Mass (gross mass)	780 kg [Rotary knife type] 788kg [Laser type] 850kg
19	Dimensions	2,180 mm (W) × 2,185 mm (L) × 1,250 mm (H)
20	Operating temperature range	5 to 35 °C [Laser type] 1 to 35 °C
21	Operating humidity range	35 to 85 % (No dew condensation) [Laser type] 5 to 70 %
22	Storage temperature range	-5 to 60 °C [Laser type] -10 to 100 °C
23	Storage humidity range	20 to 85 % (No dew condensation, 85 % applies to the case where the temperature is 40 °C or lower) [Laser type] 20 to 85 % (No dew condensation)
24	Air pressure used	0.5 to 0.6 MPa
25	Needle highest position stop facility	After the completion of sewing, the needle can be brought up to its highest position.
26	Noise	- Equivalent continuous emission sound pressure level (L <sub>pA</sub> ) at the workstation : A-weighted value of 78.0 dB ; (Includes K <sub>pA</sub> = 2.5 dB) ; according to ISO 10821- C.6.2 -ISO 11204 GR2 at 2,800 sti/min.
27	Lubricating oil	#10 (Equivalent to JUKI NEW DEFRIX OIL No. 1) #32 (Equivalent to JUKI NEW DEFRIX OIL No. 2), Lithium based grease No. 2 Grease information Manufacturer: WERATCHE Type and number: Lithium base 2# grease

## S type

Stitch pitch and the sewing speed			
Number	Stitch pitch	Sewing speed	Remarks
1	2.8 mm	2,800 sti/min	
2	3.0 mm	2,500 sti/min	
3	4.0 mm	2,200 sti/min	
4	5.0 mm	1,800 sti/min	

Note: The sewing machine must not run at the maximum number of revolutions continuously for more than 15 minutes. The number of revolutions may vary even if the pitch is consistent due to the change in the needle and material.

## H type

Stitch pitch and the sewing speed			
Number	Stitch pitch	Sewing speed	Remarks
1	3.5 mm	1,800 sti/min	
2	4.0 mm	1,600 sti/min	
3	4.5 mm	1,400 sti/min	
4	5.0 mm	1,200 sti/min	

Note: The number of revolutions may vary even if the pitch is consistent due to the change in the needle and material.

The sewing speed employed to check test sewing at the time of shipment is 2,800 sti/min for the S type or 1,800 sti/min for the H type.

The maximum number of revolutions of the sewing machine is 3,000 sti/min for both the S type and H type.

Fig. 1

## 2. CONFIGURATION

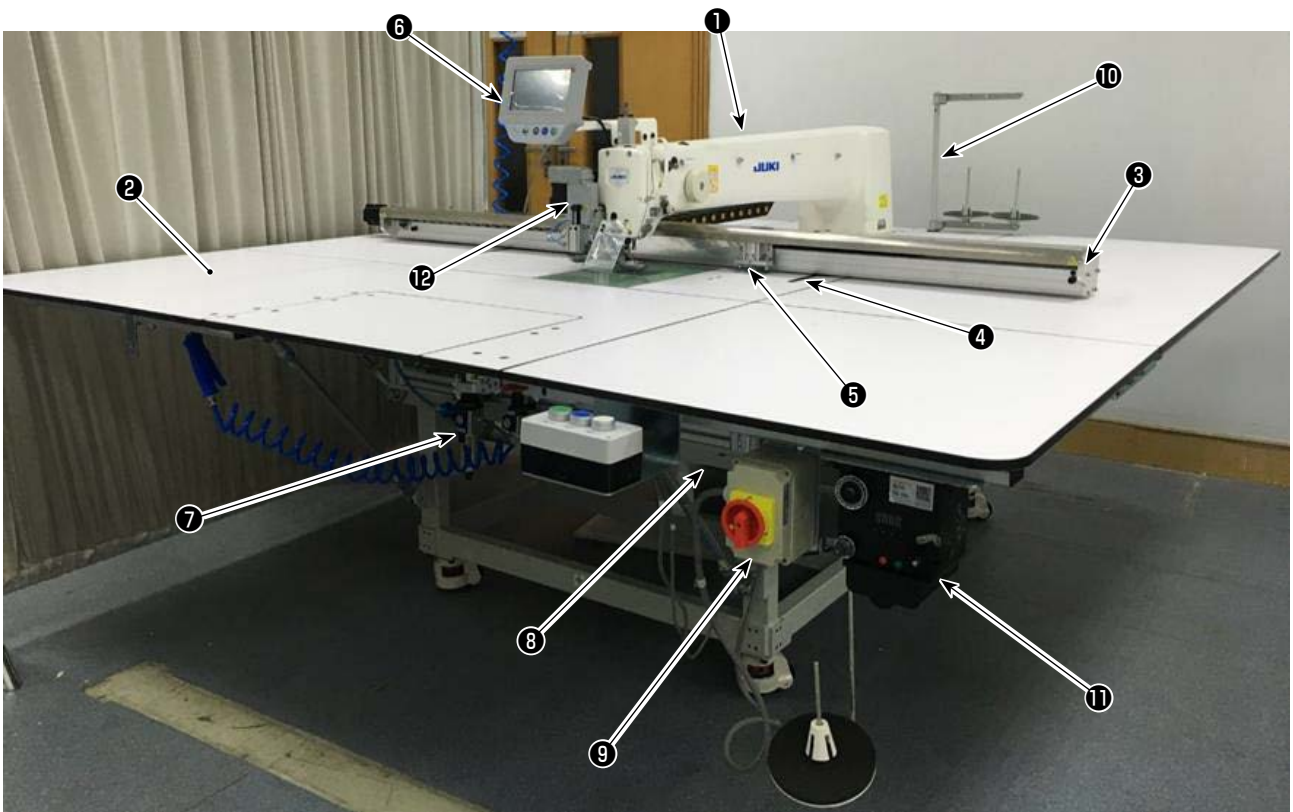

- ❶ Machine head
- ❷ Table
- ❸ X-axis feed mechanism
- ❹ Y-axis feed mechanism
- ❺ Cassette clamp device
- ❻ Operation panel
- ❼ Air control box
- ❽ Electrical control box
- ❾ Power switch (also used as the emergency stop switch)
- ❿ Thread stand
- ⓫ Bobbin winder device
- ⓬ Rotary knife device (subclass)

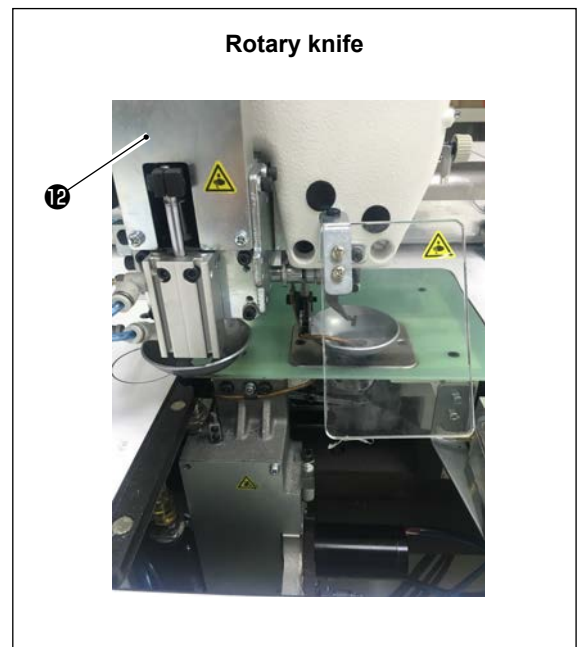

## 3. INSTALLATION

### 3-1. Setting up the sewing machine



#### 3-1-1. Unpacking

1) Lift up clamp ❶ as shown in the picture.



If the clamp is not lifted up sufficiently, unpacking will not be smoothly carried out.

2) Firstly remove upper cover ❷. Then, remove the covers of the remaining four surfaces.

3) Detach the fixed metal plate of front and rear caster seats ❸ of the sewing machine.

4) Remove the plastic cover.



5) Remove the parts, accessory box and feed mechanism from the crate.

6) Move the sewing machine to the specified place with a folk lift. (Sewing machine weighs 640 kg)

7) Turn the casters to check to make sure that the sewing machine is levelled. Also make sure that the sewing machine is placed steadily with little wobbling. Turn red pad ④ to adjust the fixing pad.

\* Necessary tools are contained in the accessory box.

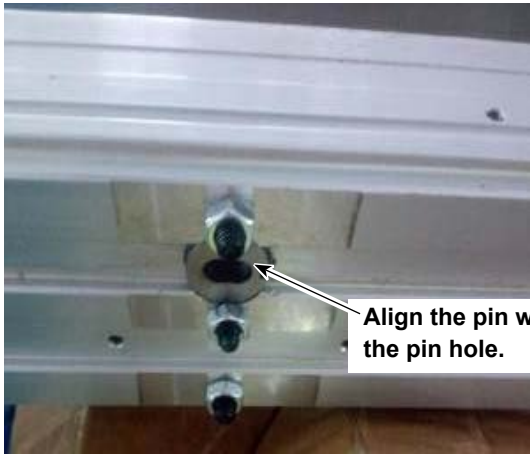
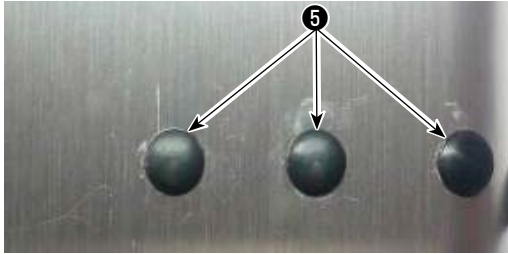
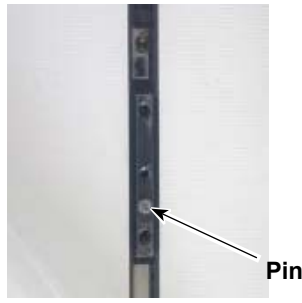

### 3-1-2. Setting up the X feed mechanism and the table

- 1) Detach the package.
- 2) Detach the fixing plate. Put the screw and nut you have detached in the accessory box.
- 3) Remove rubber plugs ⑤ . Tighten the screws that are placed under the rubber plugs with a wrench. Then, attach rubber plugs ⑤ .
- 4) Move the clamp to the center of the X feed mechanism before removing six nuts in order to prevent the clamp from interfering with screws when attaching them.
- 5) Take care not to allow the screws from slipping off the mounting holes after detaching the nuts. Put the nuts you have removed in the accessory box.

\* Store the tools in the accessory box.



### 3-1-3. Setting up the table

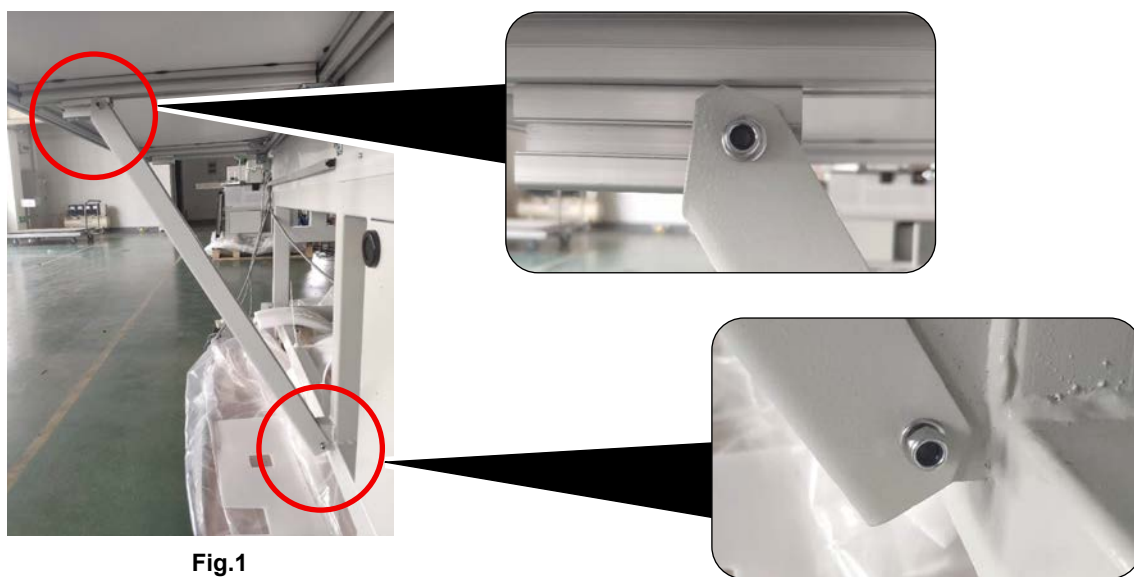

Fig.1

- 1) Set up the left, right and front (center) tables.  
Tighten the screws as illustrated in Fig. 1.



- 2) Set up the front tables (left) and (right).  
Secure the aforementioned parts with dedicated link plates ❶ and the nuts.



### 3-1-4. Setting up the switches, bobbin winder and switch button (asm.)

\* Necessary tools are contained in the accessory box.

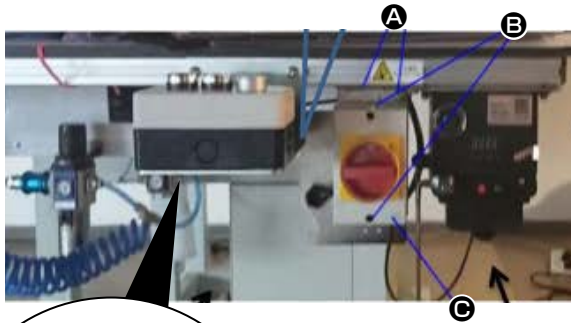

- 1) Secure the power switch plate to the aluminum frame of the front table (right) with two Phillips head screws **A**.  
Secure power switch **C** to the plate with two Phillips head screws **B**.

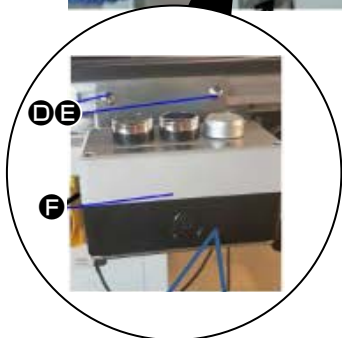

- 2) Secure switch button (asms.) **F** to the aluminum frame of the front table (right) with T screws **E** and nuts **D**.  
Secure three switch buttons so that they point upward.

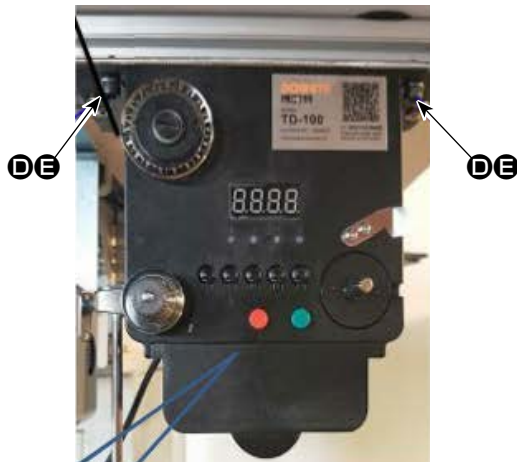

- 3) Secure the bobbin winder to the aluminum plate of the front table (right) with T screw **E** and nut **D**.



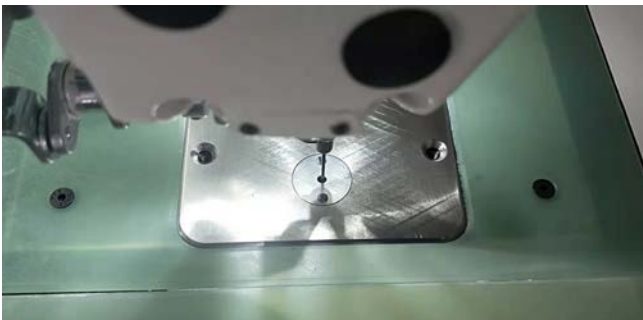

### 3-1-5. Check points and precautions before turning the power ON

- 1) Inspect the levelness of the sewing machine.
- 2) Inspect that the electric components and pneumatic components of the sewing machine have been securely assembled.
- 3) Inspect the alignment between the needle entry point and the center of needle hole in the throat plate of the sewing machine.
- 4) Detach the throat plate and inspect the relation between the needle and the hook.
- 5) Check the clearance provided between the X feed origin detection sensor and the detection plate.
- 6) Check that the X feed mechanism moves smoothly.

## 3-2. Installing the air hose



### WARNING :

Check to be sure that the air hose is fully inserted into the air cock before supplying the air to the machine so as to prevent the air from being blown directly to the human body. Then, carefully open the air cock.



### 1) Connecting the air hose

Connect the air hose to ❶ .

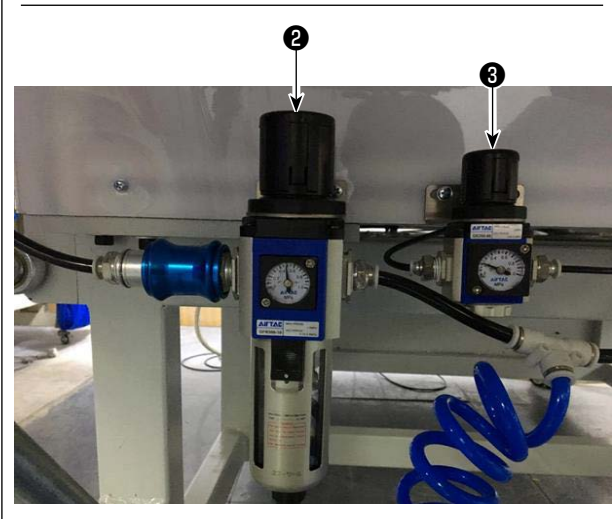

### 2) Adjustment of air pressure

Pull up air regulating knob ❷ . Then, turn it to adjust the air pressure to 0.5 - 0.55 MPa.

Then, push down air regulator knob ❷ .

Pull up air regulating knob ❸ . Then, turn it to adjust the air pressure to 0.15 MPa.

Then, push down air regulator knob ❸ .

❷ : Adjustment of the air pressure of the entire sewing machine

❸ : Adjustment of the air pressure of the disk presser

### 3-3. Cautions for the compressed air supply (source of supply air) facility

As large as 90 % of failures in pneumatic equipment (air cylinders, air solenoid valves) are caused by "contaminated air."

Compressed air contains lots of impurities such as moisture, dust, deteriorated oil and carbon particles. If such "contaminated air" is used without taking any measures, it can be a cause of troubles, inviting reduction in productivity due to mechanical failures and reduced availability.

Be sure to install the standard air supply facility shown below whenever the machine provided with pneumatic equipment is used.

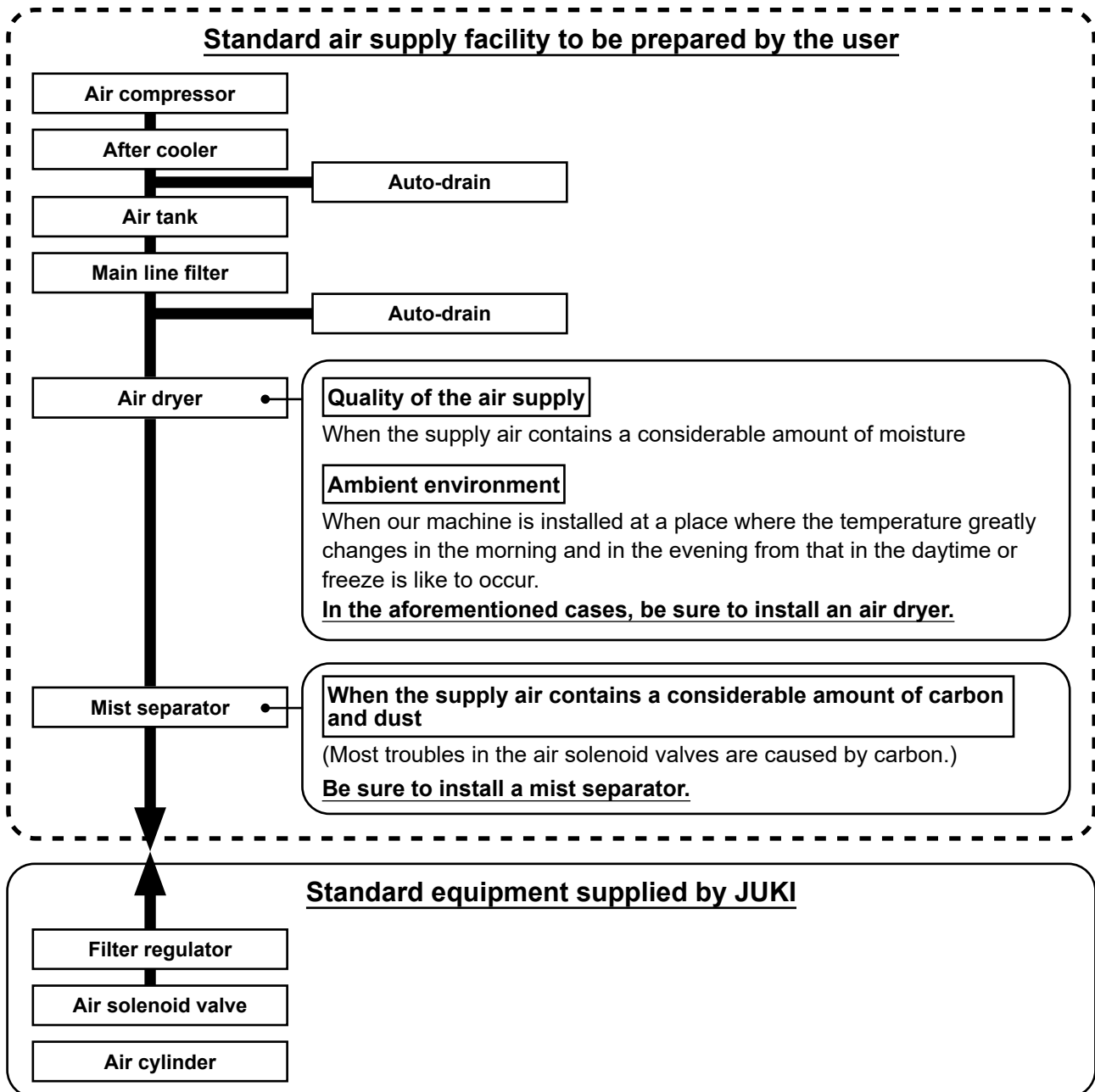

#### **Cautions for main piping**



- Be sure to slope main piping by a falling gradient of 1 cm per 1 m in the direction of air flow.
- If the main piping is branched off, the outlet port of the compressed air should be provided at the top part of the piping using a tee in order to prevent drain settling inside the piping from flowing out.
- Auto drains should be provided at all lower points or dead ends in order to prevent the drain from settling in those parts.

### 3-4. Installing the bobbin winder device

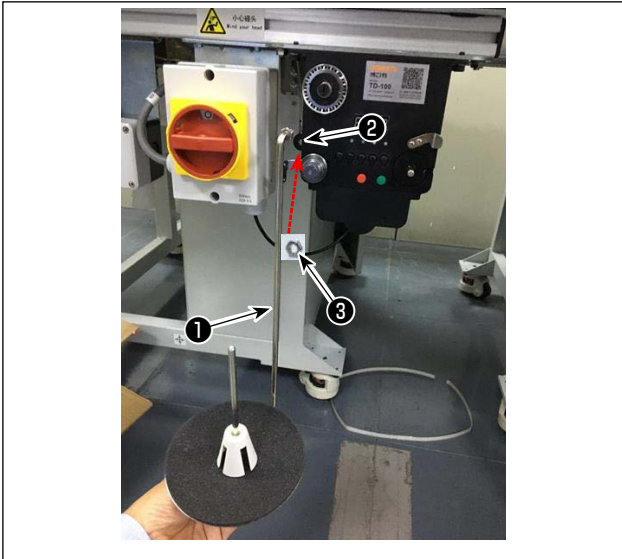

- 1) Insert bobbin winder disk mounting bar ① into hole ② in the bobbin winder and secure with nut ③.

### 3-5. Winding the bobbin thread

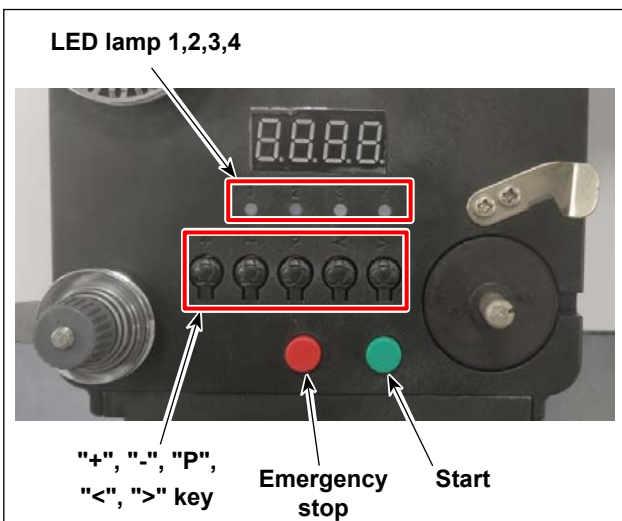

LED lamp 1,2,3,4

"+", "-", "P", "<", ">" key

Emergency stop

Start stop

#### 4. Threading Diagram

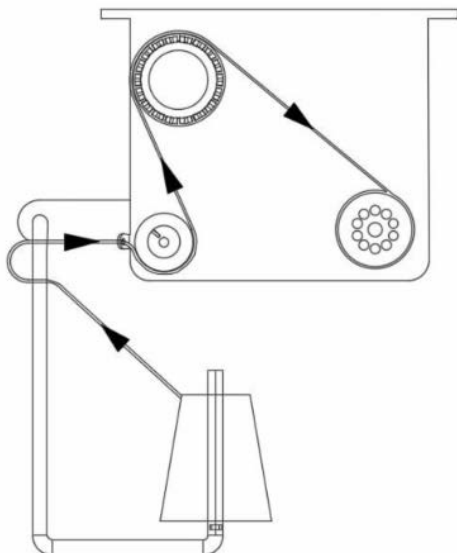

#### 1. Button description

- 1) Red button: emergency stop, press this button for 2 seconds will be reset.
- 2) Green button: Start
- 3) "P" key: function key, Hold down "P" key for 2 seconds to enter parameter setting, after setting is finished, press this key again for 2 seconds to keep parameter.
- 4) "+" key: numbers from 0 to 9
- 5) "-" key: numbers from 9 to 0
- 6) "<" key: turn left
- 7) ">" key: turn right

#### 2. Indicator light

- 1) Parameter indicator light
- 2) Production failure indicator light
- 3) Stop indicator light
- 4) Work indicator light

#### 3. Parameter setting

Hold down "P" key for 2 seconds to enter the parameter setting inter face.

A: The thread length setting is 0 to 99.9 meters

B: Compensate for 0 to 9.9 meters

C: The bobbin calculate to thread length 0 to 99.9 meters

D: Motor speed: F1 (fast), F2 (medium), F3 (slow)

E: LED lamp brightness: H0 (OFF), H1 (darkest), H2, H3, H4, H5 (brightest)

### 3-6. Precautions for installation of the machine

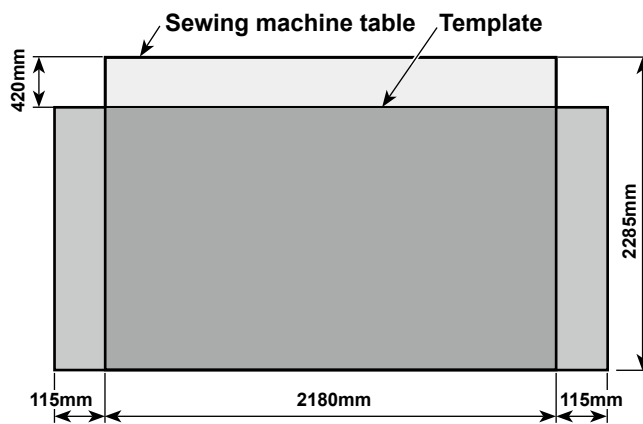
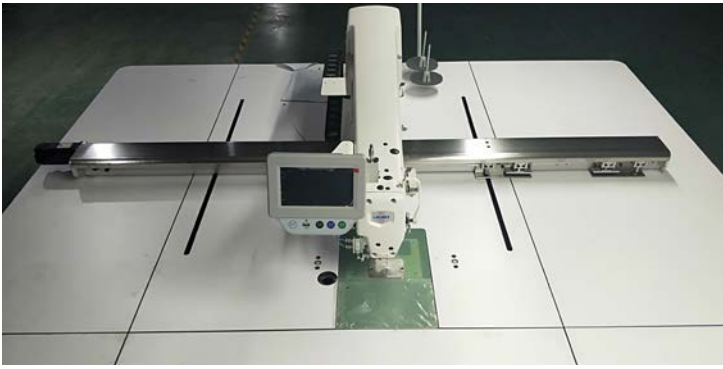

1. Depending on the size of template, the sewing machine may extend beyond the sewing machine table in X direction. Take care not to allow the machine to hit against someone standing near the table to cause injury.
2. Be sure to secure a space as wide as 500 mm or more around the sewing machine table (i.e., both in lateral and longitudinal directions).

## 4. PREPARATION OF THE SEWING MACHINE

### 4-1. Lubricating method and check of the oil quantity



#### WARNING :

Turn OFF the power before starting the work so as to prevent accidents caused by abrupt start of the sewing machine.

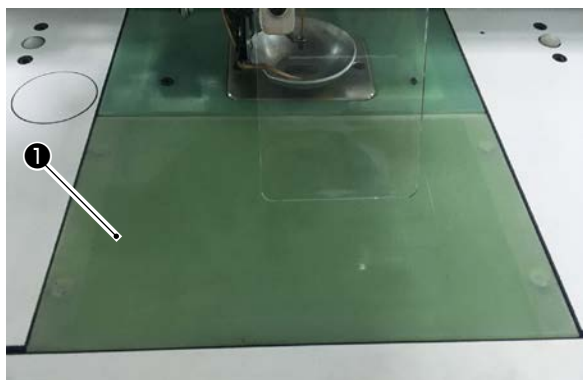

1) Detach cylinder lifting plate ❶ .

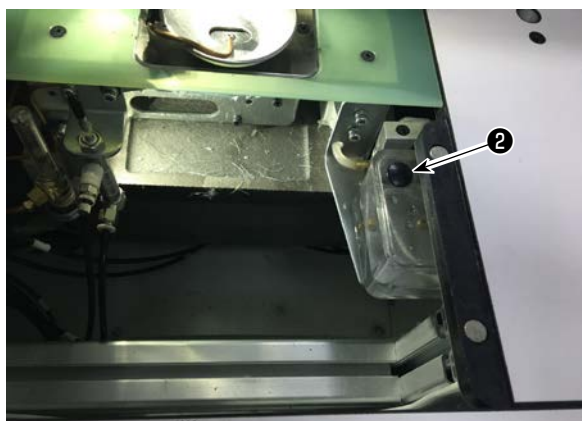

2) Remove rubber plug ❷ from the oil tank.



3) Fill the oil tank with the accessory oil (or the specified oil).

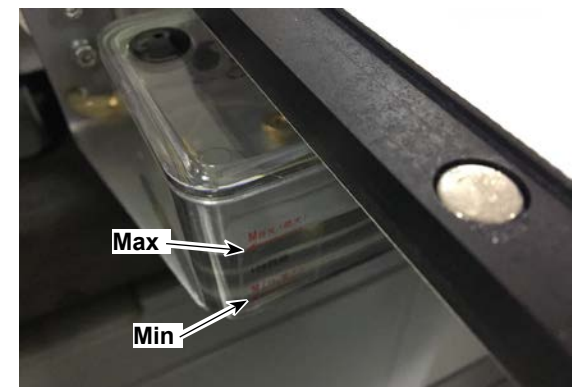

4) The adequate oil amount is obtained when the oil surface stays between the oil tank indications "Min" and "Max".

1. Do not use any oil other than the specified oil. After the completion of lubrication, securely attach the rubber plug and cylinder lifting plate to their original positions.



2. When you put the sewing machine into use for the first time after delivery or after having disused it for a long time, replenish the hook with a small amount of oil in advance.



## 4-2. Attaching the needle



### WARNING :

Turn OFF the power before starting the work so as to prevent accidents caused by abrupt start of the sewing machine.

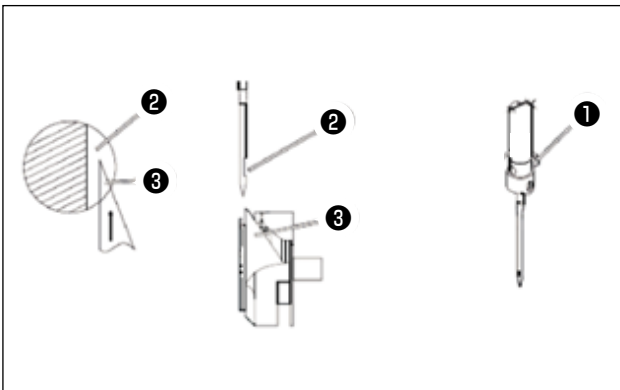

1) Loosen screw ❶ to remove the needle.



Be sure to hold the needle so that its groove ❷ faces toward blade point ❸ of the rotary hook.

2) Tighten screw ❶ .



In the case of replacing the needle with a needle which differs in specifications, be sure to re-adjust the distance from the rotary hook to the needle. If you neglect this re-adjustment, the problems listed below can occur.

1. Stitch skipping
2. Thread fray
3. Breakage of blade point of hook
4. Breakage of needle

### 4-3. Threading the machine head



**WARNING :**

Turn OFF the power before starting the work so as to prevent accidents caused by abrupt start of the sewing machine.

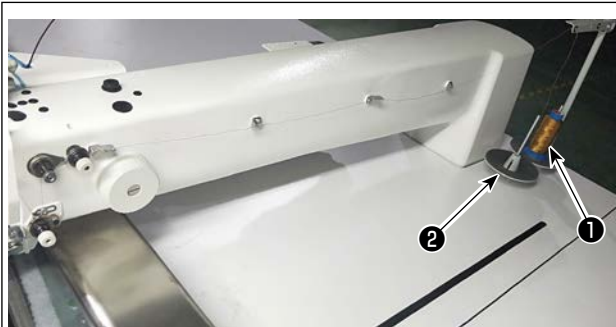

1) Put sewing machine thread ① on thread stand ②.



2) Pass the thread as illustrated in the figure.

Lastly, draw out thread end through needle eyelet by 50 to 60 mm.



## 4-4. Bobbin replacement procedure



### WARNING :

Turn OFF the power before starting the work so as to prevent accidents caused by abrupt start of the sewing machine.

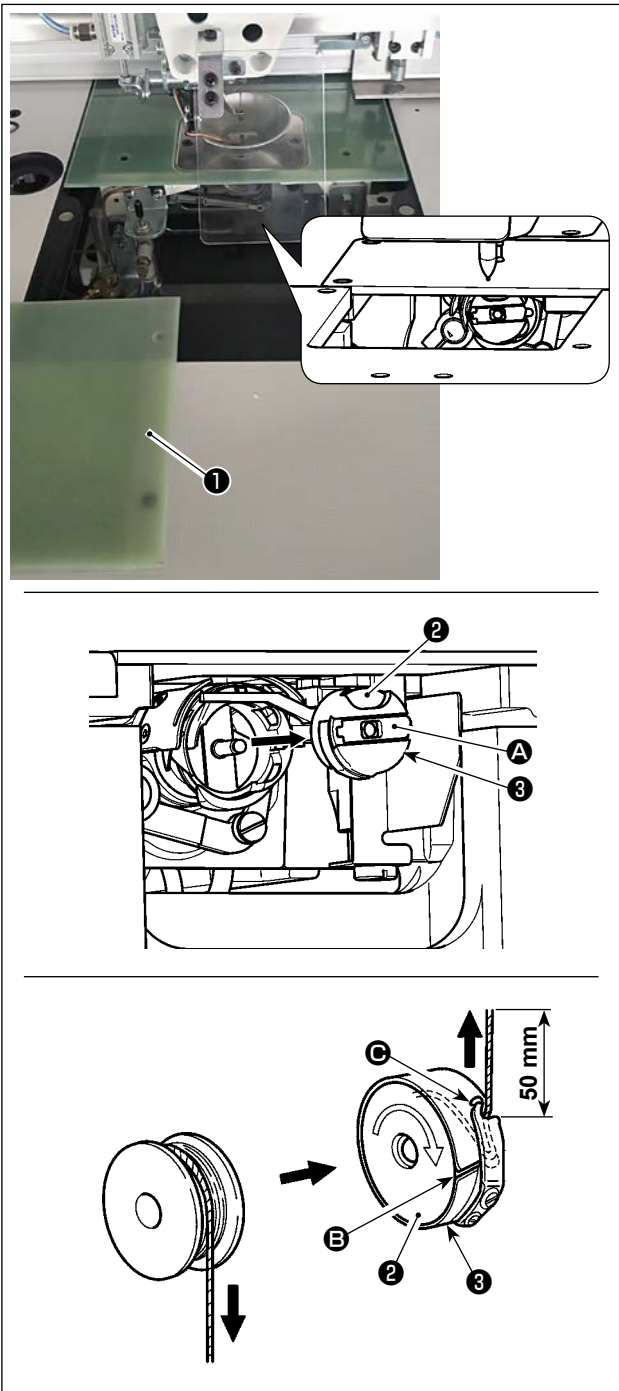

### (1) Removing the bobbin case

- 1) Open cover ① . Then, the bobbin can be changed.
- 2) Raise latch A of bobbin case ③ , and remove the bobbin case ③ and the bobbin ② .



Check the position of your hands and the locations of goods before opening / closing cover ① so as to prevent the goods from being caught under the cover and to prevent bodily injury.  
In addition, do not push cover ① with your hands placed on it.

### (2) Installing the bobbin

- 1) Set the bobbin ② into bobbin case ③ in the direction shown in the figure.
- 2) Pass the thread through thread slit B of bobbin case ③ , and pull the thread as it is. By so doing, the thread will pass under the tension spring and be pulled out from thread hole C.
- 3) Pull out the thread by 50 mm from thread opening C.



If the bobbin ② is installed in the bobbin case orienting the reverse direction, the bobbin thread pulling out will result in an inconsistent state.

### (3) Installing the bobbin case

- 1) Place the bobbin case in the hook with its knob A tilted and fully push it into the hook until you hear it click.
- 2) Close cover ① .



If it is not fully inserted, bobbin case ③ may slip off during sewing.

## 4-5. Adjusting the thread tension

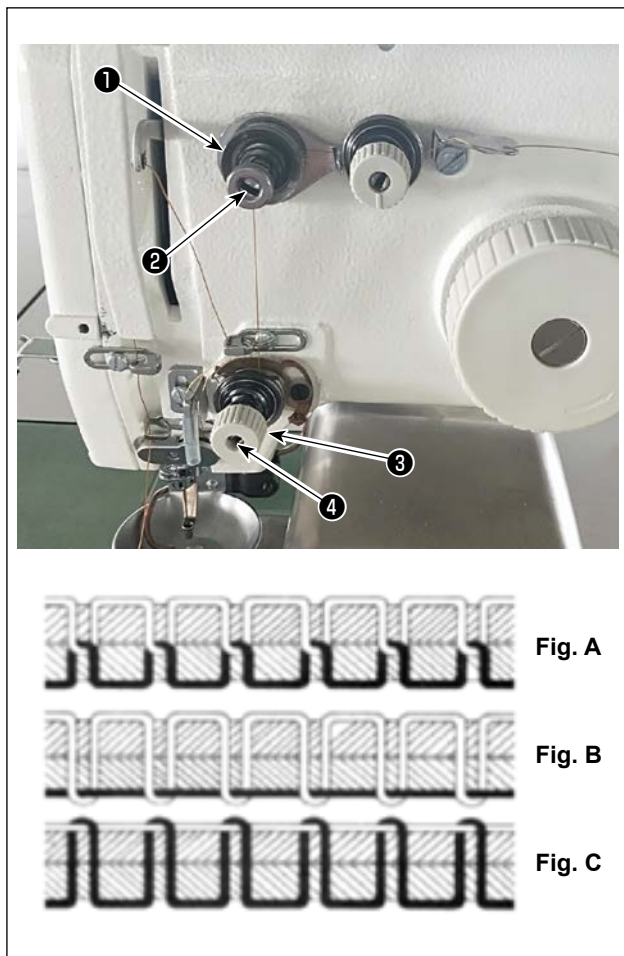

### (1) Adjusting the needle thread tension

#### Thread tension controller No. 1 ①

When the tension disk of thread tension controller No. 2 ③ is loosened, such a small tension as to control the thread trimmer has to remain. The remaining tension is produced by tension controller ①. It is possible to determine the length of thread trailing from the needle after automatic thread trimming by adjusting nut ② of the thread tension controller. The length of thread trailing from the needle is reduced by turning nut ② clockwise (+). It is increased by turning nut ② counterclockwise (-).

#### Thread tension controller No. 2 ③

The tension (applied to the thread coming from the needle) controlled with thread tension controller No. 2 ③ should be set as low as possible so that the needle thread and bobbin thread are interlaced together at the center of material thickness (Fig. A). If the thread tension is excessively high when sewing a light-weight material, the material may become wrinkled or thread may break. The tension applied to the thread coming from the needle is increased by turning nut ④ clockwise (+). It is decreased by turning nut ④ counterclockwise (-).

Fig. A: Threads are interlaced together accurately at the center of material thickness.

Fig. B: Needle thread tension is too low or bobbin thread tension is too high.

Fig. C: Needle thread tension is too high or bobbin thread tension is too low.

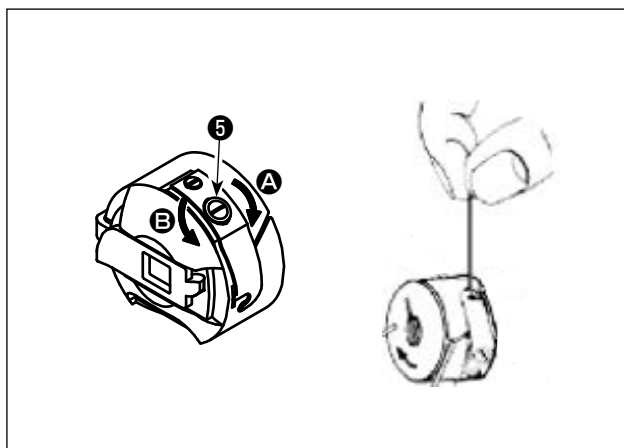

### (2) Adjusting the bobbin thread tension

1) Turn tension adjusting screw ⑤ clockwise (in direction A) to increase or counterclockwise (in direction B) to reduce the bobbin thread tension. Recommended value: Approximately 25 g  
The bobbin case will come down slowly by its dead weight by holding it as illustrated in the figure.

## 4-6. Adjusting the thread take-up spring and the thread breakage detector plate

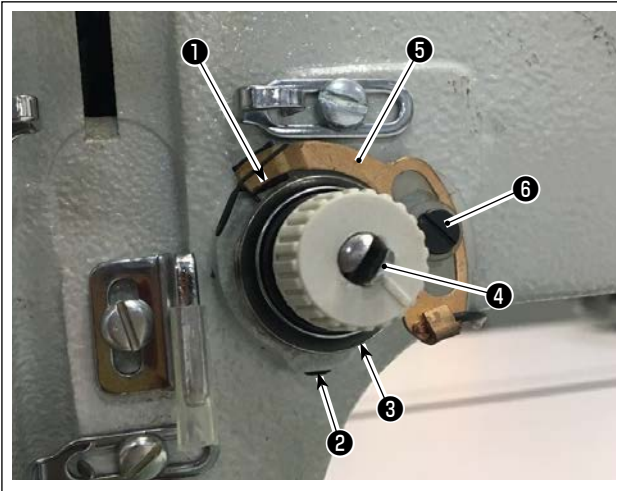

- 1) Adjusting the stroke  
Loosen setscrew **2** . Turn thread tension controller **3** . Turning it clockwise will increase the stroke of the thread take-up spring **1** and the thread drawing amount will increase.
- 2) Adjusting the pressure  
To change the pressure of the thread take-up spring **1** , insert a thin screwdriver into the slot of thread tension post **4** while screw **2** is tightened, and turn it. Turning it clockwise will increase the pressure of the thread take-up spring **1** . Turning it counterclockwise will decrease the pressure.
- 3) Adjusting the thread breakage detector plate  
Loosen setscrew **6** . Adjust the position of thread breakage detection plate **5** so that the contact depth between thread breakage detection plate **5** and thread take-up spring **1** becomes 0 to 0.2 mm.



Adjust so that thread breakage detector plate **5** does not touch any adjacent metallic parts other than thread take-up spring **1** . If the thread breakage detection plate comes in contact with any other metal part, a maloperation can occur.

## 4-7. Adjusting the thread take-up stroke

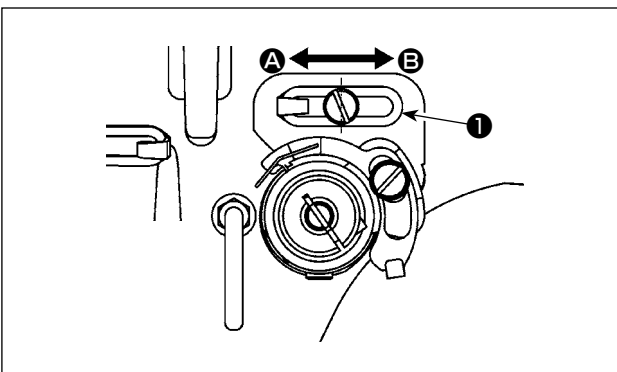

- 1) When sewing heavy-weight materials, move thread guide **1** to the left (in direction **A**) to increase the length of thread pulled out by the thread take-up.
- 2) When sewing light-weight materials, move thread guide **1** to the right (in direction **B**) to decrease the length of thread pulled out by the thread take-up.
- 3) Normally, thread guide **1** is positioned in a way that the center of elongated hole is aligned with the center of the screw.

## 4-8. Needle-to-hook relationship



### WARNING :

Turn OFF the power before starting the work so as to prevent accidents caused by abrupt start of the sewing machine.

### (1) Needle and hook, and angle setting

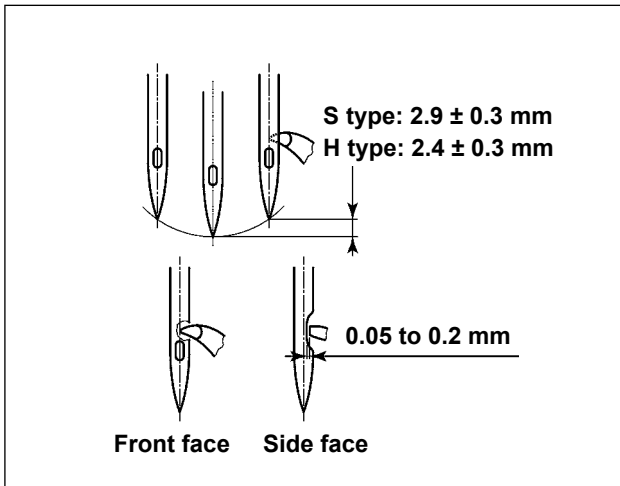

- 1) For the S type, the relation between the needle bar height and the hook position should be adjusted when the needle bar goes up from its lower dead point by  $2.9 \pm 0.3$  mm. For the H type, it should be adjusted when the needle bar goes up from its lower dead point by  $2.4 \pm 0.3$  mm.
- 2) When observing from the front face of the sewing machine, the blade point of hook seems to overlap with the center of needle.
- 3) When observing from the side face of the sewing machine, the clearance provided between the blade point of hook and the scarf of needle is 0.05 to 0.2 mm.

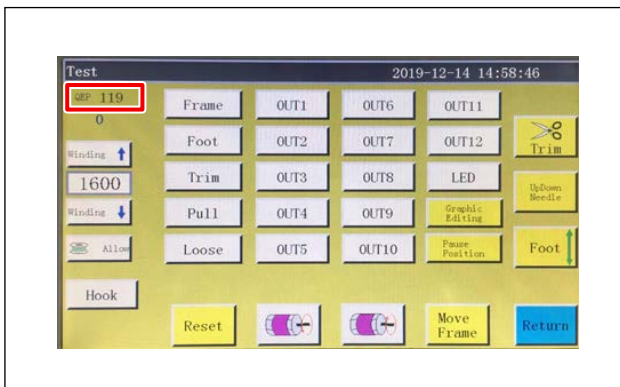

**Caution**  
If thread breakage occurs, the thread can be tangled in the hook. In such a case, remove the thread being tangled in the hook carefully. Then, re-start sewing.

- 4) As shown in the figure, the electrical shaft angle setting QEP value displayed on the operation panel becomes 570 to 575.

### (2) Position of the needle and the inner hook holder

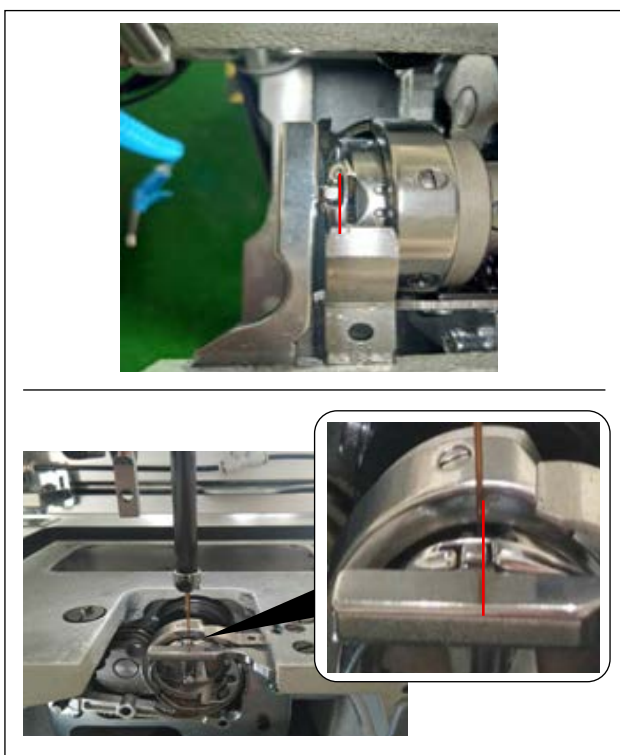

Longitudinal position of the inner hook holder and needle: The front end of needle is aligned with the inner hook.

Lateral position of the inner hook holder and needle: The rightmost end of projection of inner hook holder is aligned with the right side of needle.

### (3) Adjusting the hook timing

The timing gauge is supplied for the machine as an accessory.

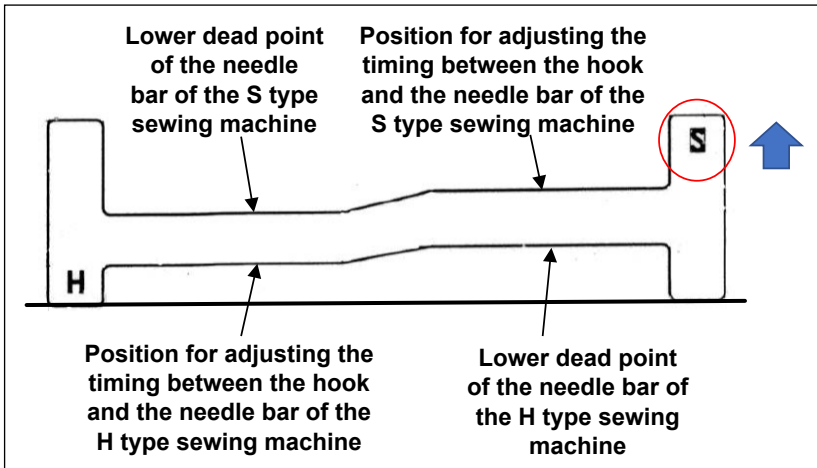

Adjust the hook timing according to the sewing type (S type / H type) of the sewing machine.

Turn the timing gauge upside down according to the sewing machine type as shown in the figure on the left.

For the S type :

Position the timing gauge with its S inscription turned up

For the H type :

Position the timing gauge with its H inscription turned up

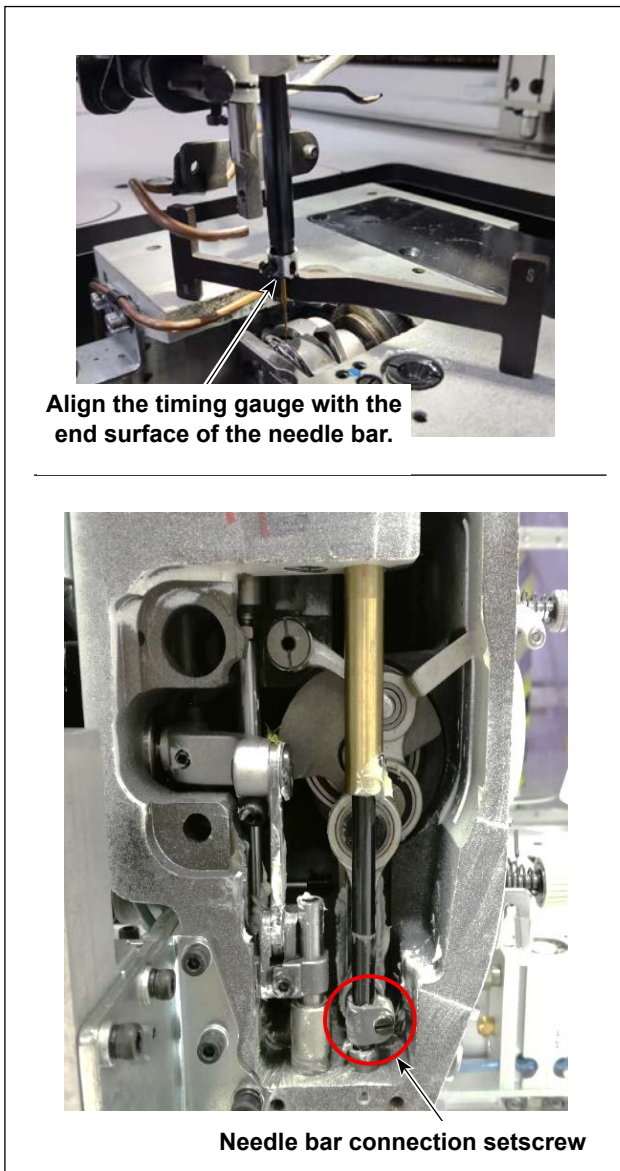

1) Put the timing gauge on the hook spindle base. Then, adjust the lower dead point of the needle bar first.

Loosen needle bar connection setscrew. Adjust the height of the needle bar.

2) Then, turn the timing gauge by 180 degrees of an angle longitudinally. Adjust the hook timing position.

**Caution**  
When adjusting the hook timing, it is necessary to put the jig on the left side of the needle to prevent the jig from coming in contact with the needle bar thread guide.

## 4-9. How to wind a bobbin

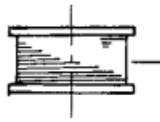
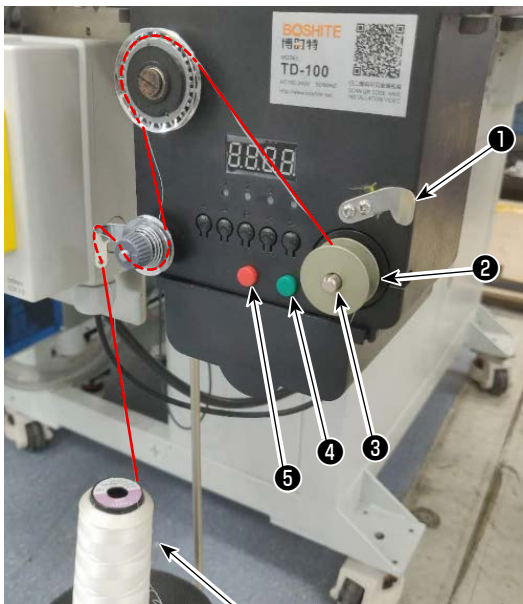

**Amount of thread wound on a bobbin: 80 %  
(recommended)**

- 1) Put bobbin ② on bobbin winder shaft ③ .
- 2) Pass sewing thread ⑥ through spool rest rod.
- 3) Pass the thread as illustrated in the figure.
- 4) Manually wind thread on bobbin ② by several turns clockwise.
- 5) Press button ④ to start winding thread on the bobbin.
- 6) When the bobbin thread amount wound on the bobbin reaches the set amount (80 %), the bobbin winder automatically stops turning. Or, press button ⑤ to stop the bobbin winder.
- 7) Trim the thread with thread trimmer ① . Detach bobbin ② .



## 4-10. Adjusting the position of the thread trimmer



### WARNING :

Turn OFF the power before starting the work so as to prevent accidents caused by abrupt start of the sewing machine.

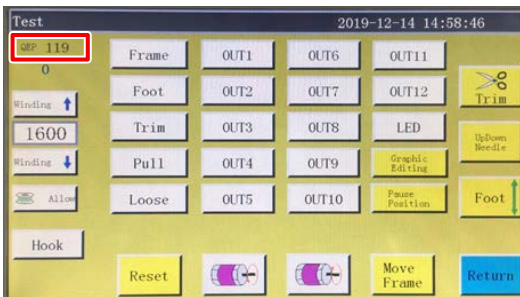
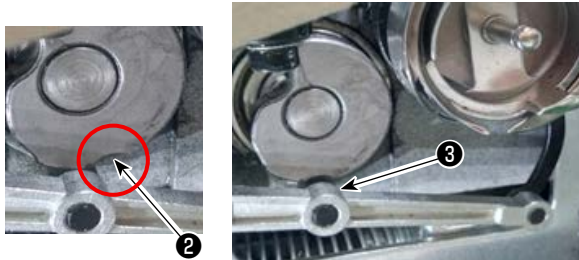
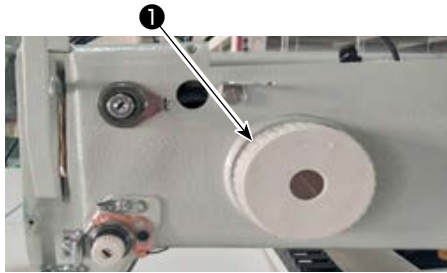

### (1) Adjusting the position of the thread trimming cam

- 1) Turn pulley ① to engage needle bearing ③ of the thread trimmer connecting rod with groove ② in the thread trimming cam.

The specified QEP value of the electrical shaft angle setting parameter has been factory-adjusted to 290 at the time of shipment. Finely adjust the parameter according to the difference in material.

The moving knife is in parallel with the moving knife base

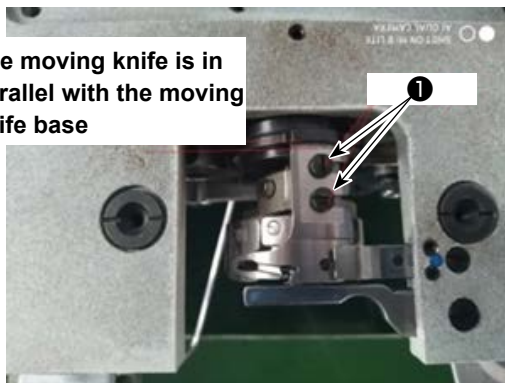

### (2) Adjusting the position of the moving knife and counter knife

- 1) Attach the moving knife to the moving knife base. Push the moving knife to the right to make the tail of the moving knife in parallel with the moving knife base. At this time, the blade point of moving knife is aligned with the needle. Tighten moving knife clamping screw ①.

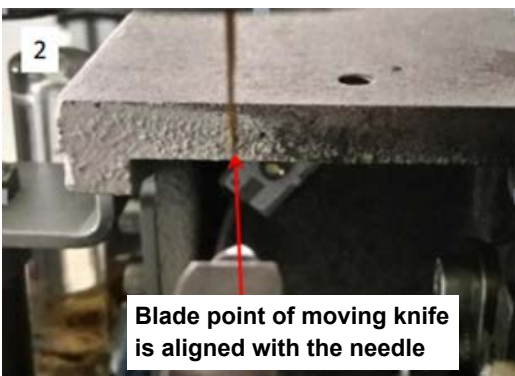

Blade point of moving knife is aligned with the needle





## 2) Attaching the counter knife

The tail portion of the counter knife has a hole. Inserting 2.5 hexagonal wrench key ② into that hole, tighten the fixation screw of the counter knife while aligning the tail portion of the counter knife with the hexagonal wrench key.

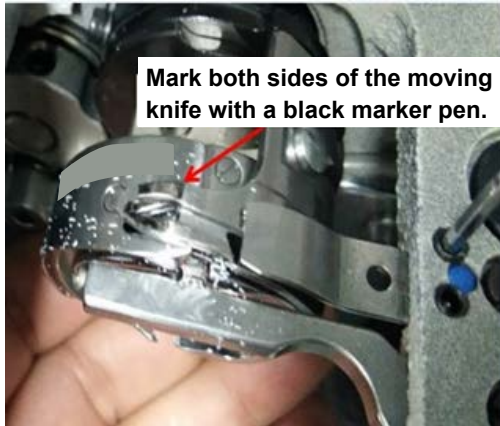

## 3) Mark the 5 mm position of the moving knife blade with a black marker pen. Adjust the counter knife pressure with counter knife pressure adjustment screw ③ .

After you have completed adjustment, push down the moving knife to re-adjust the moving knife pressure in repetition until both sides, with black markers, of the moving knife are simultaneously rubbed by the counter knife without fail. In addition, the friction force between the moving knife and the counter knife can be minimized by trimming three used machine-sewing threads.

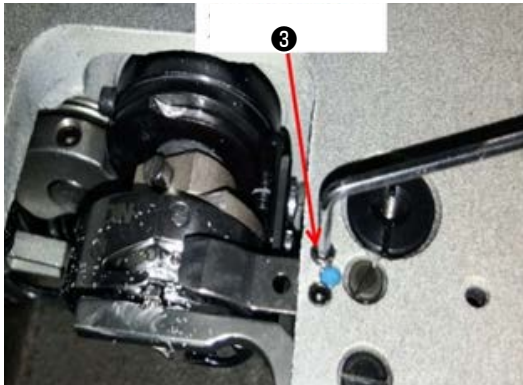

## 4-11. How to attach / remove the cylinder lifting plate

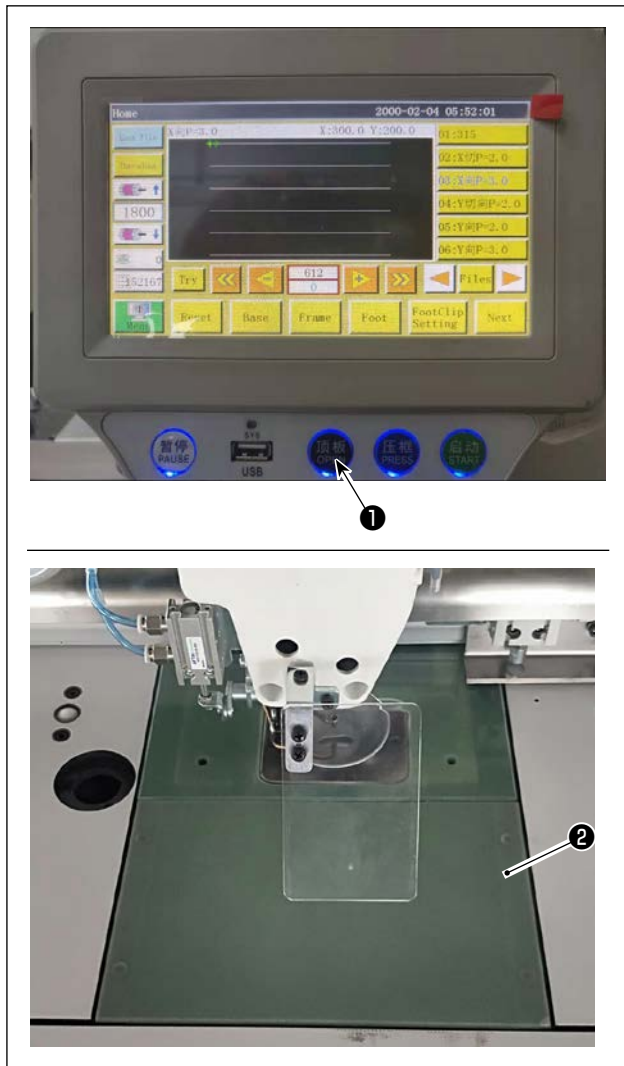

1) While the power to the sewing machine is turned ON, press switch ① .

2) Cylinder lifting plate ② comes off upward. Remove it. (The cylinder pushes up the lifting plate.)

3) To install cylinder lifting plate ② , press switch ① . (The cylinder comes down to allow the cylinder lifting plate to be installed. The lifting plate is then secured with a magnet.)

## 4-12. How to confirm the amount of oil (oil splashes) in the hook



### WARNING :

Be extremely careful about the operation of the machine since the amount of oil has to be checked by turning the hook at a high speed.

### (1) How to confirm the amount of oil (oil splashes)

#### ① Amount of oil (oil splashes) confirmation paper

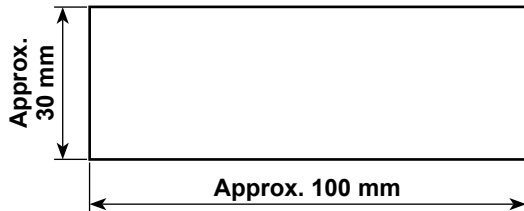

\* Use any paper available regardless of the material.

#### ② Position to confirm the amount of oil (oil splashes)

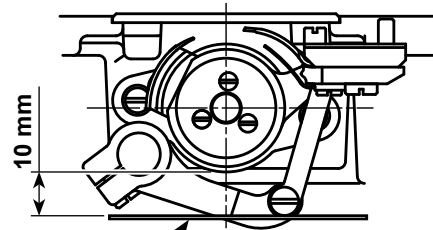

Oil splashes confirmation paper



When carrying out the procedure described below, confirm the state that the needle thread from the thread take-up lever to the needle and the bobbin thread are removed, the presser foot is lifted and the slide plate is removed. At this time, take extreme caution not to allow your fingers to come in contact with the hook.

- 1) Check to make sure that the oil quantity is adequate referring to "[4-1. Lubricating method and check of the oil quantity](#)" p.13.
- 2) If the machine has not been sufficiently warmed up for operation, make the machine run idle for approximately fifteen minutes.
- 3) Place the amount of oil (oil splashes) confirmation paper under the hook while the sewing machine is in operation.
- 4) Confirmation of the amount of oil (oil splashes) should be completed in ten seconds.

### (2) Sample showing the appropriate amount of oil (oil splashes)

#### Appropriate amount of oil (State of oil spots)

Splashes of oil from the hook

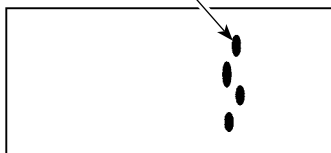

- 1) The state given in the figure above shows the appropriate amount of oil (oil splashes).
- 2) Check the oil amount (oil splashes) three times (on the three sheets of paper), and adjust so that it should not change.



Do not excessively increase/decrease the amount of oil in the hook. If the amount of oil is too small, the hook will be seized (the hook will be hot). If the amount of oil is too much, the sewing product may be stained with oil.

## 4-13. Adjusting the amount of oil in the hook



### WARNING :

Turn OFF the power before starting the work so as to prevent accidents caused by abrupt start of the sewing machine.

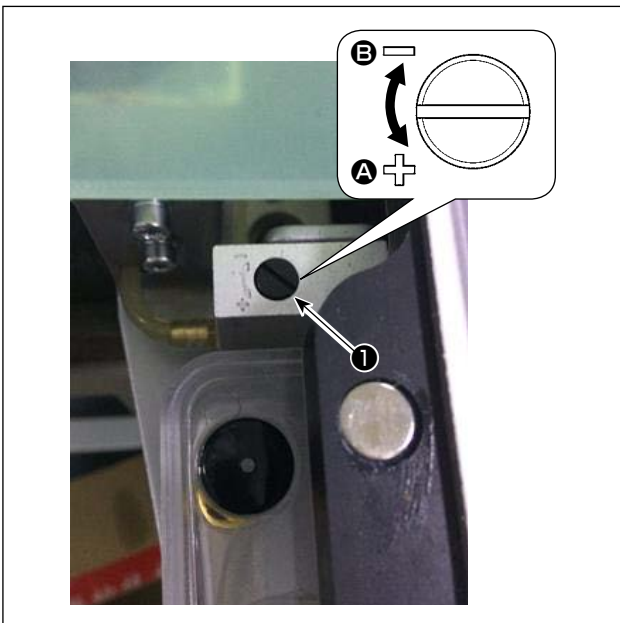

- 1) Remove the cylinder lifting plate.
- 2) The oil amount is increased by turning screw ① in the direction of arrow ➀, or decreased by turning it in the direction of arrow ➁.
- 3) After the completion of adjustment, attach the cylinder lifting plate.



1. After the adjustment, check the oil quantity by running the sewing machine idle for approximately 30 seconds, as well as by checking it in comparison with the sample showing the adequate oil quantity. (Refer to "4-12. How to confirm the amount of oil (oil splashes) in the hook" p.25.)
2. In the case of adjusting the hook oil quantity, firstly adjust the oil quantity by turning oil quantity adjustment screw in the direction of arrow ➀ to increase it. Then, adjust the hook oil quantity by turning the adjustment screw in the direction of arrow ➁ to decrease it.
3. The hook oil quantity has been factory-adjusted at the time of shipment, based on the maximum sewing speed of sewing machine. When the customer always operate the sewing machine at a low speed, the hook oil quantity may run short causing a sewing machine failure. To prevent such a failure, adjustment of the hook oil quantity is required when the customer runs the sewing machine at a low speed at all times.

#### 4-14. Adjusting the needle hole in the throat plate and the needle



**WARNING :**

Turn OFF the power before starting the work so as to prevent accidents caused by abrupt start of the sewing machine.

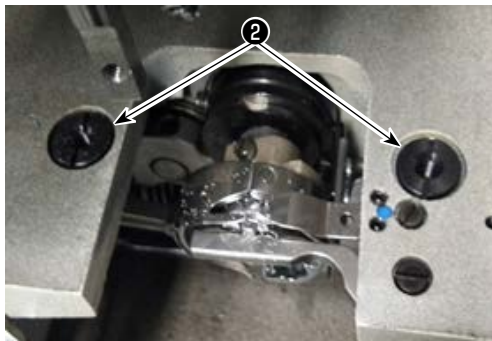

In the case the needle does not come down to the center of needle hole in the throat plate, the position of the throat plate can be adjusted with screw ❶ .

- 1) Remove the throat plate.
- 2) Loosen two needle hole adjustment eccentric screws ❷ of the throat plate. Adjust the position of the throat plate so that the needle is aligned with the center of needle hole in the throat plate by moving the throat plate.
- 3) Tighten needle hole adjustment eccentric screws ❷ of the throat plate.

## 4-15. Setting the mechanical origin



1

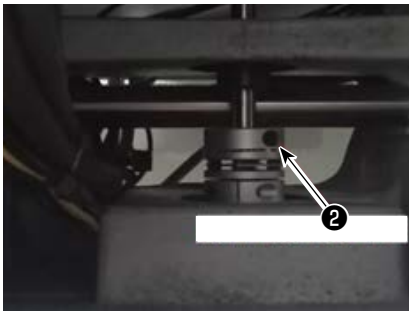

2



3

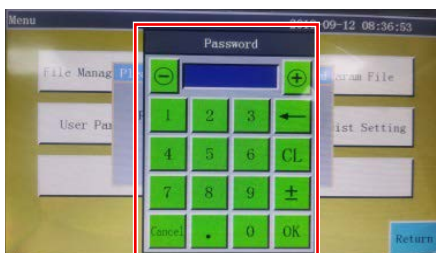
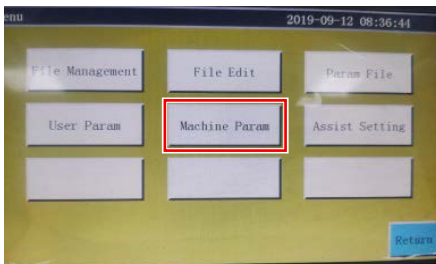

4



- 1) Slightly tighten screw 2 on the lower shaft side. Then, turn the pulley to position screw 1 on the main shaft motor so that it is levelled and faces upward.
- 2) Holding the pulley, press  3 on the main screen of the electrical box.
- 3) When you press the "Machine setting parameter", 4 is displayed. When you enter password "11111111", screen 5 is displayed.
- 4) On the screen that is displayed by pressing the "Axial angle setting", set the QEP value to 245, tighten screw 1 on the main shaft motor side, and loosen screw 2 on the lower shaft side. Then, turn the pulley to bring the needle bar to its upper dead point.
- 5) Holding the pulley (not to allow the needle bar to move), click the "QEP value" of the "Axial setting parameter" on the screen. Adjust the QEP value to 0 (zero). Then, tighten screw 2 on the lower shaft side.
- 6) At this point, the origin adjustment has been completed. Now, turn the pulley again to check that the QEP value of the needle bar at its upper dead point is 0 (zero). As long as the aforementioned QEP value is 0 (zero), the mechanical origin has been adjusted properly.

5

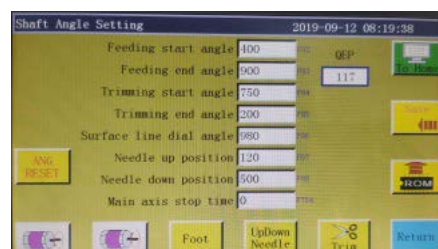
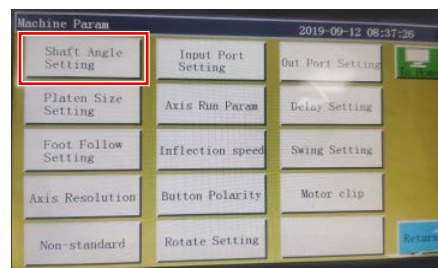

## 4-16. Adjusting the disk presser pressure

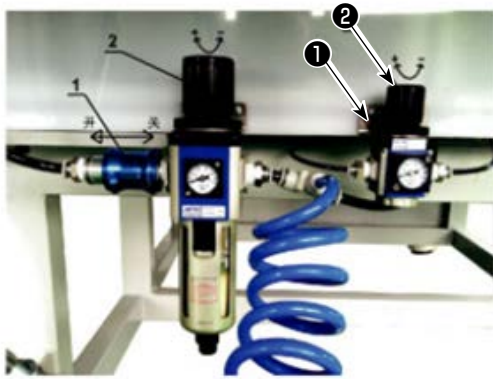

1) Adjust the disk presser air cylinder pressure regulation valve **1** . Pull up nut **2** . Then, turn the nut clockwise to increase the disk presser pressure or turn it counterclockwise to decrease it. The air pressure has been factory-set to 0.15 MPa at the time of shipment. Adjust it appropriately while checking the actual sewing state.

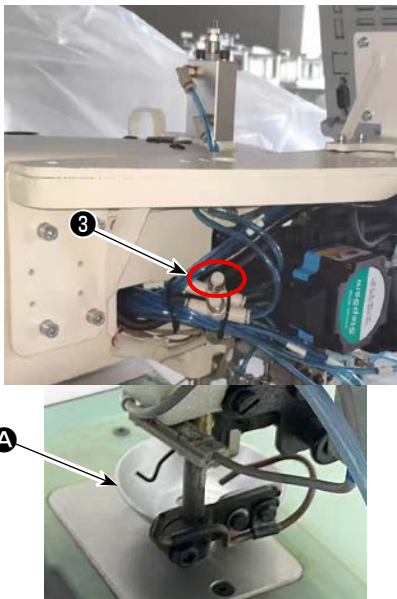

2) To slow down the sewing speed when the disk presser is placed at its upper position, adjust speed controller **3** .

### 3) Changing the disk presser

Check the actual sewing operation. Use the disk presser or the plastic disk presser according to the condition of actual sewing operation.

**A** Disk presser (factory-attached at the time of shipment)

**B** Plastic disk presser

When changing the disk presser with the plastic disk presser or vice versa, try to position the disk presser so that its bottom surface is in parallel with the hook cover. Adjust the height of the disk presser according to the actual material thickness (i.e., height) while taking care not to allow the disk pressers to come in contact with the intermediate presser.

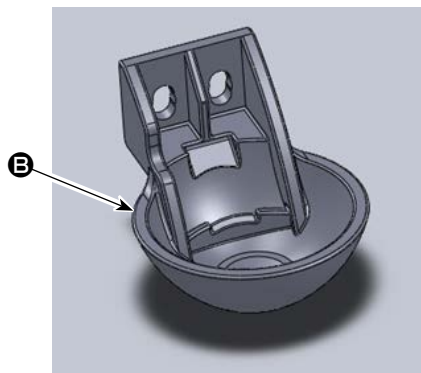



## 4-17. Adjusting the thread end position at the beginning of sewing

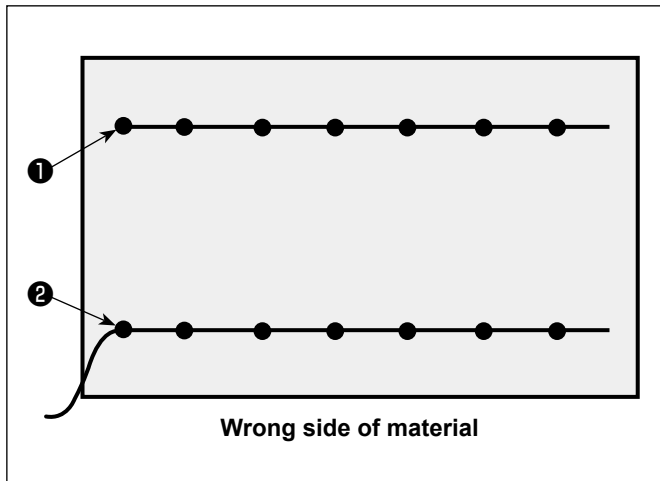

It is possible to set the needle thread end position at the beginning of sewing to top side ❶ or underside ❷ of material.

Change over the setting of the wiper function between ON and OFF in accordance with these two conditions of the needle thread end position.

❶ To put the needle thread end on the top of material

Place the wiper function in OFF.

❷ To put the needle thread end on the underside of material

Place the wiper function in ON.

## 4-18. Adjusting the electronic intermediate presser stroke

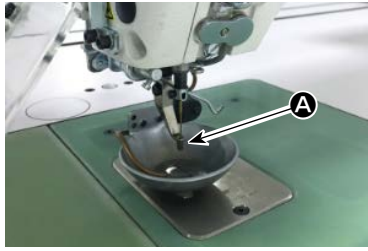

It is necessary to adjust the intermediate presser stroke (A) appropriately since there would be the need for preventing stitch skipping depending on thickness or type of the material.

- 1) Press  ① on the main screen of electrical box.
- 2) When you press the "Machine setting parameter", ② is displayed.  
When you enter the password "11111111", screen ③ is displayed.
- 3) On the screen that is displayed by pressing the "Presser follow-up setting", set the parameter (the follow-up height of presser foot has been factory-adjusted to 2 mm at the time of shipment).

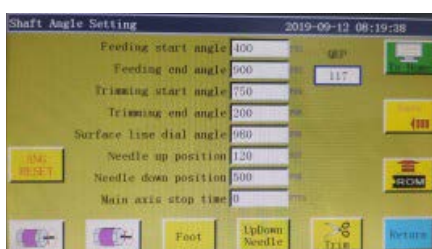
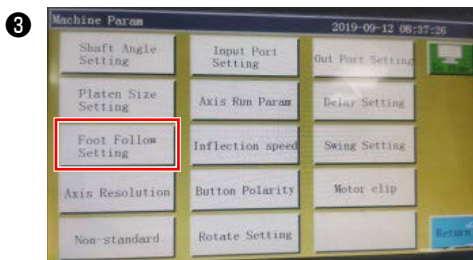
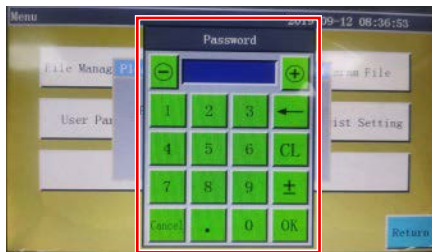
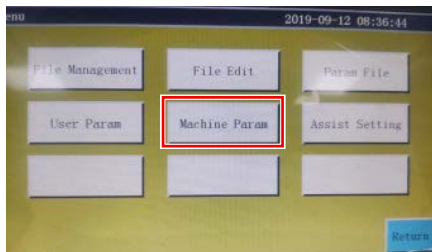

## 4-19. Adjusting the air blow for the needle thread and bobbin thread



Blow-up pipe ① blows air to blow up the thread end trailing from the needle to bring it under disk presser ② at the beginning of sewing by controlling the solenoid valve of the electrical system.

Thread end is pushed by air between the disk presser and the pattern at the beginning of sewing. In the case the thread end cannot be pushed due to the location and direction of slits on the pattern, adjust the blowing direction of the air to allow the thread end to be pushed by air.

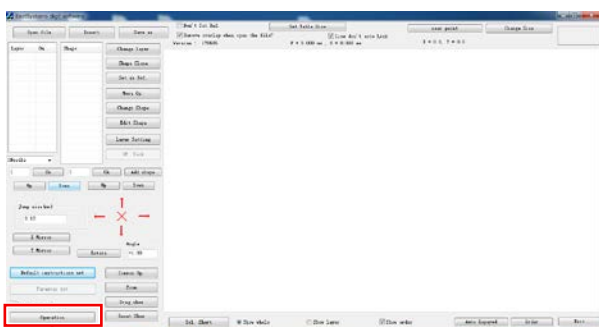

Launch the pattern creation software to operate and process the pattern to be sewn.

On the screen that is displayed by clicking "Operation processing" ③, click ④ ("Enter I/O") and change the "I/O" to 5.

Change the "Level" to "high" ("low" refers to "turning OFF"). Click ⑤ ("Delay"). Change the "Delay (msec)" to 225.

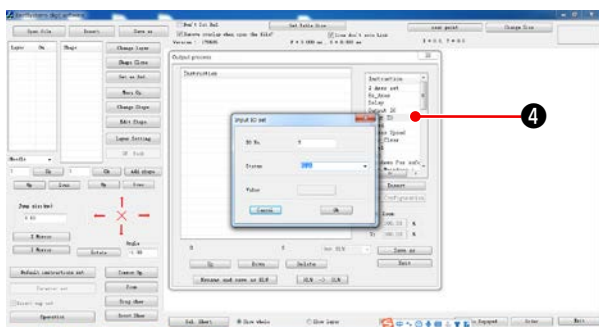

**The needle thread air blower and the wiper cannot be used simultaneously.**

1. The wiper provides the function for bringing the needle thread above the presser foot.

2. The needle thread air blower provides the function for bringing the needle thread under the disk presser.

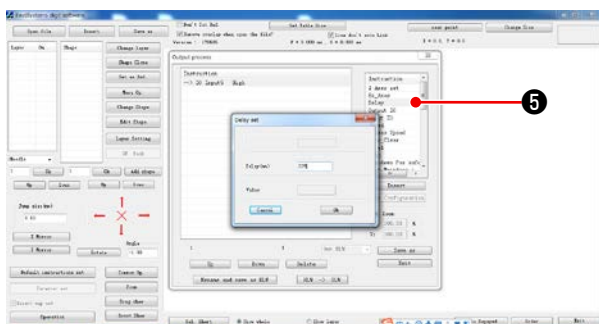

## 4-20. Making a template

### (1) Machining a template

12080 type template of dimensions of the maximum sewing range

- Material of template: PVC plate
- Template thickness: 1.5 mm thick PVC plate
- Adjust the template size according to the cloths and/or pattern to be sewn.  
The size must not exceed the maximum dimensions of the relevant specifications.
- Check complexity of the pattern to be sewn. Then, select the sewing slits from the range of 6 mm to 8 mm according to the complexity of the pattern.
- Locus of sewing slits on the template should be designed according to the pattern to be sewn or intended machining.
- Select the suitable pattern carving machine. The template must be machined by the qualified engineers who have successfully finished the on-the-job training.
- After the completion of machining upper and lower templates, deburr the templates and the top surface of the template mounting plate.

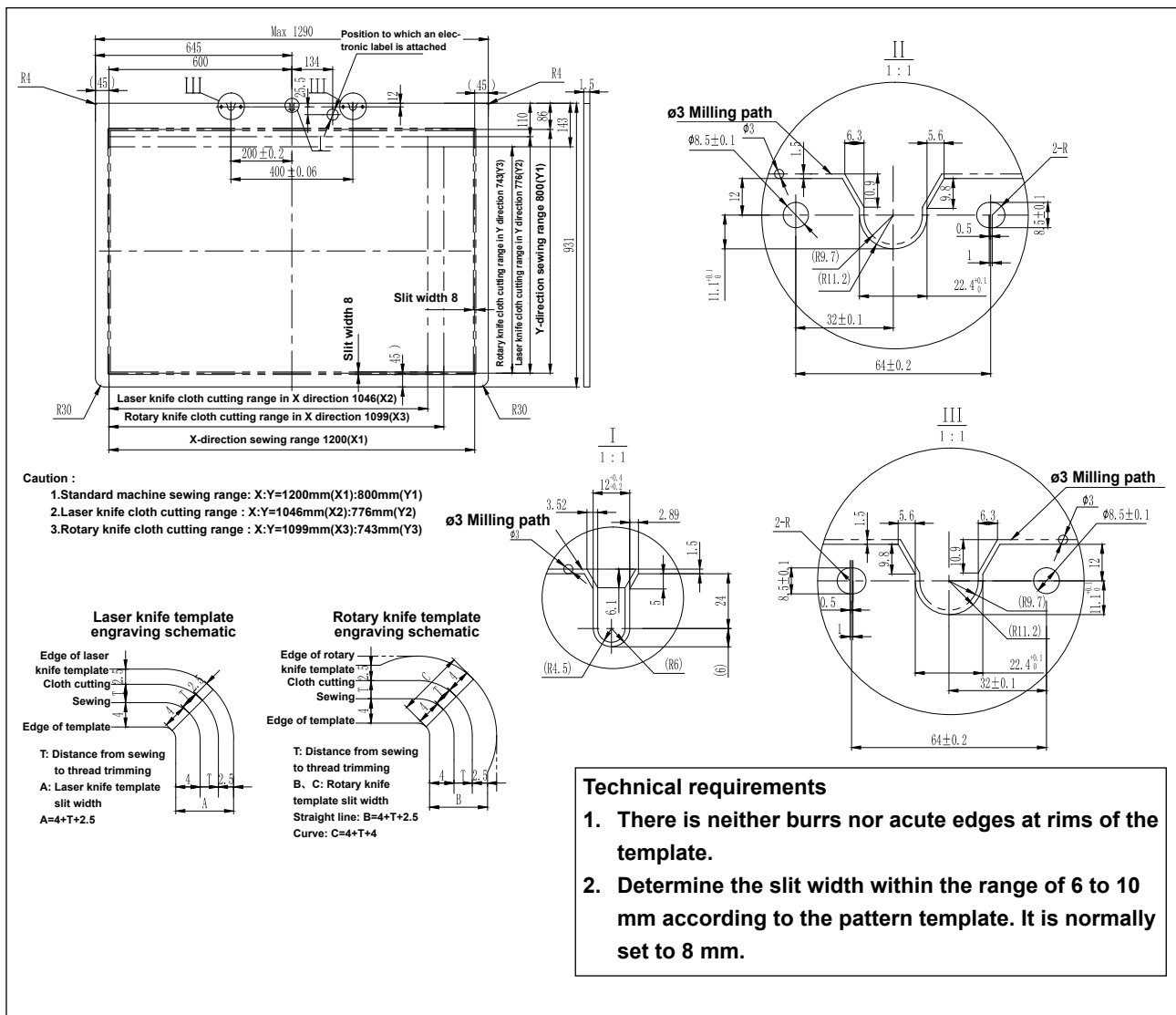

## (2) Attaching the templates

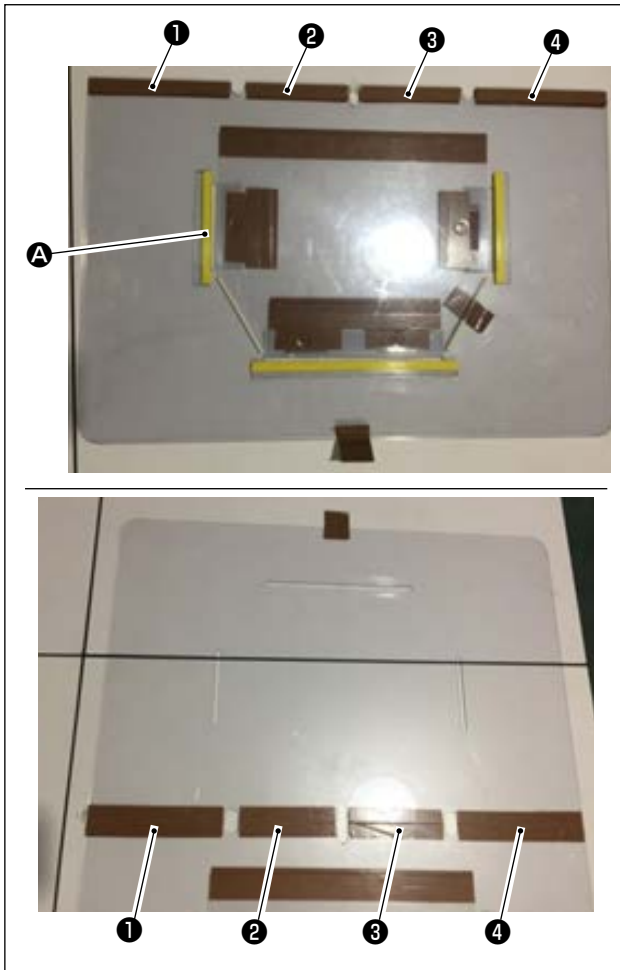

Machine the upper and lower templates based on the design.

- 1) Put the upper template on the lower template, as shown in the figure, and adjust so that sewing slits **A** on the upper and lower templates are aligned. Affix exclusive template tape (36 mm wide) to portions **1**, **2**, **3** and **4** as illustrated in the figure.
- 2) To produce more beautiful seams, it is recommended to firmly secure the material at the correct position by affixing sand tape, double-sided adhesive tape, etc. on the slits of the upper and lower templates or put positioning pins at appropriate locations in order to prevent the material slippage.

## 4-21. Preparation for sewing



- 1) Turning ON the main power switch.  
Press button ❶ to turn ON the main power switch.
- 2) Turning ON the main air source switch  
Move main air valve ❷ to the right to open the main air source.

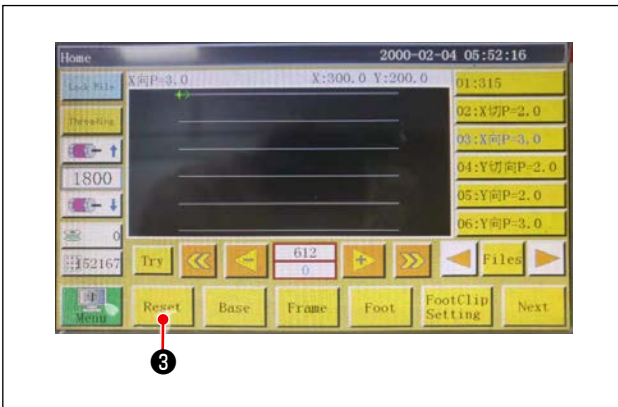

- 3) Resetting the equipment  
When the equipment is reset by pressing  ❸, the needle stops at its upper stop position, and the disk presser and intermediate presser go up.
- 4) Read the pattern data to be sewn, or directly edit the pattern data on the operation panel.  
Refer to the Instruction Manual for the computer-control system for details.

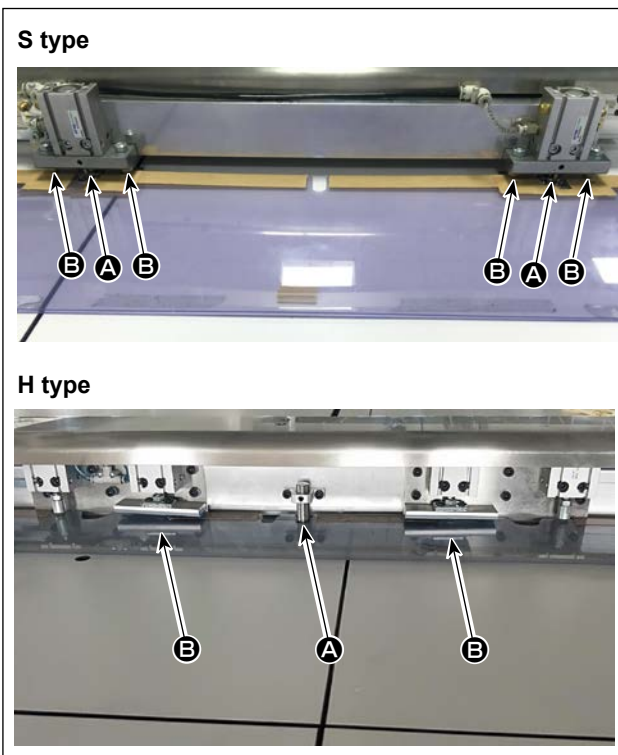

- 5) Attaching a pattern  
Moving an empty pattern (with no material), fit positioning hole ❶ on the pattern positioning plate on the positioning pin. Fit other two auxiliary positioning holes ❷ on the positioning sleeves and fully push them until they will go no further.

### 6) Reading the sewing pattern data

1. In the case an IC tag is attached to the pattern, the electrical system will automatically identify the sewing pattern program that matches the pattern from among those stored on the IC tag.
2. In the case no IC tag is attached to the pattern, manually select the sewing pattern data that matches the relevant pattern on the operation screen.

\* Refer to "4-23. Configuration of the operation panel" p.39 for how to use the IC tag.

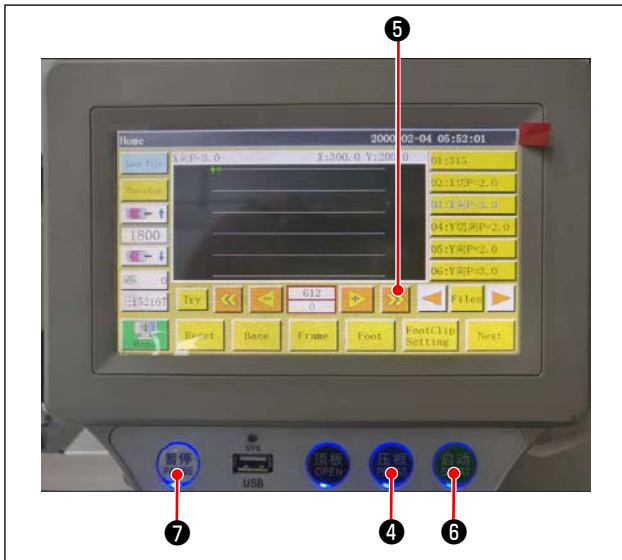

### 7) Selecting the reference

In order to align the locus of sewing pattern with the sewing slits of the pattern, it is necessary to set a reference. Specifically, set the reference referring to the Instruction Manual for the electrical system scanner.

After the completion of establishment of a reference, display the operation screen. When you keep button 5 held pressed, the pattern locus simulation sewing starts.

Operate the sewing machine once to check whether or not the sewing pattern locus is aligned with the pattern slits. If they are not aligned, re-adjust the reference.

To stop the operation while the simulation operation is being carried out, press button 7 to stop it.

### 8) Placing the material to be sewn

#### 1. Detaching the pattern

When you move the pattern to the reset position and press clamp button 4 on the operation panel, two air cylinders on the X-direction linear module release the pattern. Take out the pattern.

#### 2. Placing the material

Place the material to be sewn on the pattern. Then, check that the material is neatly arranged horizontally. In addition, secure the material with the holding method that matches the pattern to prevent the material from moving out of position. If the material has an infill of feather or cotton, squeeze the material to push out air as far as possible.

### 9) Setting the reset, pattern on which the material is placed, and the reference

- \* Carry out resetting following the step of procedure 3).
- \* Handling of the pattern on which the material is placed is described in the step of procedure 5).
- \* Reference setting is carried out following the step of procedure 7).

### 10) Starting

Press the start button 6 on the operation panel to start sewing. Then, the sewing machine enters the automatic sewing mode.

### 11) Temporary stop

If any accident occurs during sewing, press the temporary stop button 7 on the operation panel. Then, the sewing machine immediately stops operation.

### 12) Re-starting

Once the aforementioned accident is eliminated, turn temporary stop button 7. Then, the button pops up and the emergency stop mode is reset. Then, press start button 6 to re-start automatic sewing.

## 4-22. RFID (How to use the IC tag)

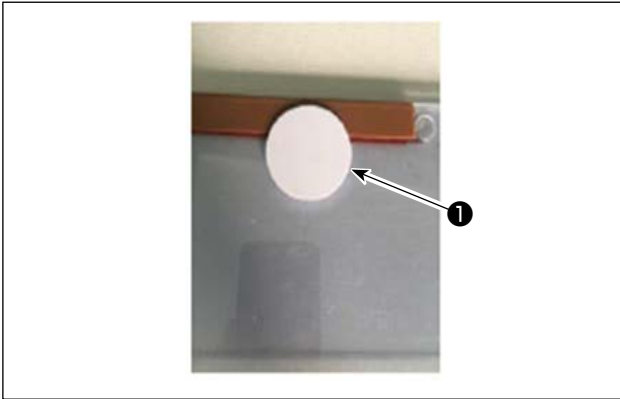

### 1. Attaching the IC tag

Attach IC tag ① onto the pattern with double-sided adhesive tape or the like.

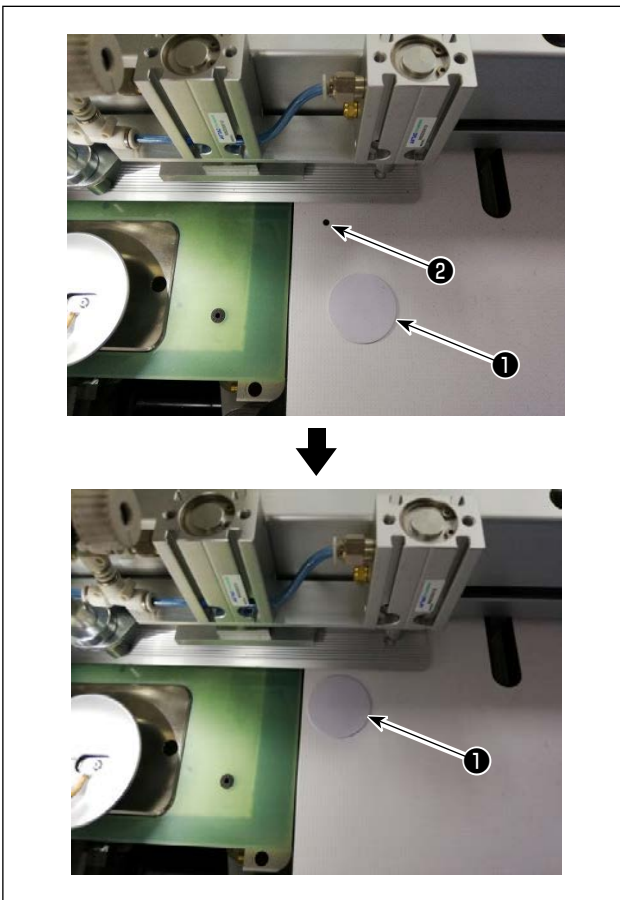

### 2. Writing sewing pattern data

1) Place IC tag ① on black dot ② on the sewing machine table.



2) Press "Menu" ③ on the initial screen.



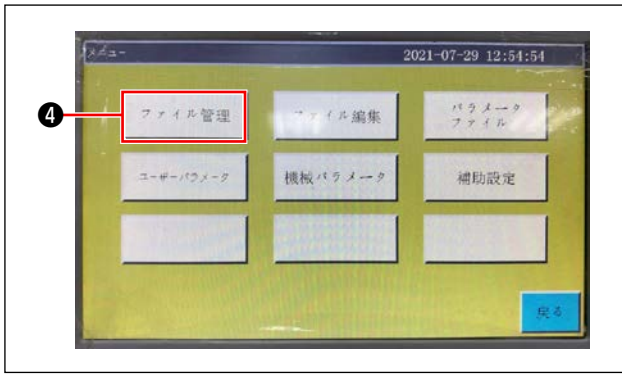

3) Press the "File Management" ④ on the menu screen.

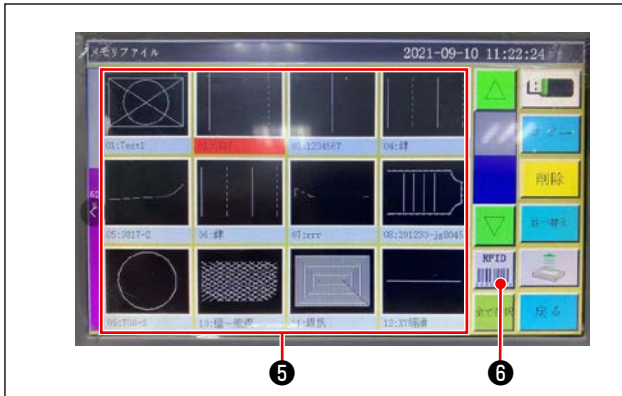

4) Select sewing pattern data ⑤ you want to write on the IC tag on the memory file screen. After you have made a selection, press "RFID" ⑥ to write the sewing pattern data on the IC tag.



### 3. Loading sewing pattern data

- 1) On the initial screen, press the "Self-lock" ① button.
- 2) Place the IC tag with the sewing pattern data written on it on the black dot on the table.
- 3) The sewing pattern data written in the IC tag is read.

## 4-23. Configuration of the operation panel

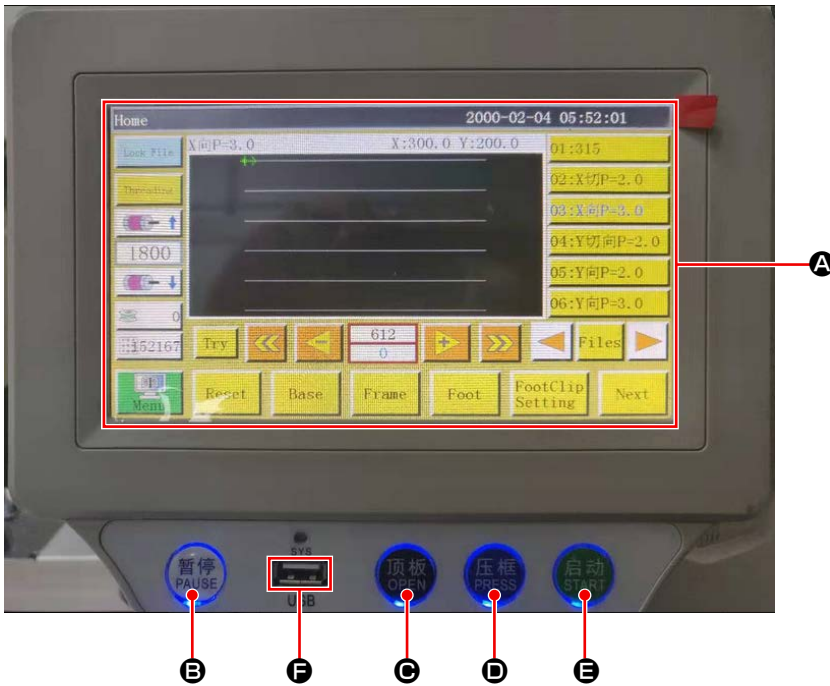

<b>A</b>	LCD portion of the touch panel	
<b>B</b>	PAUSE key	Used to temporarily stop sewing
<b>C</b>	OPEN key	Move the cylinder lifting plate up and down.
<b>D</b>	PRESS key	Used to move up/down the cassette holder
<b>E</b>	START key	Used to start sewing
<b>F</b>	USB port	

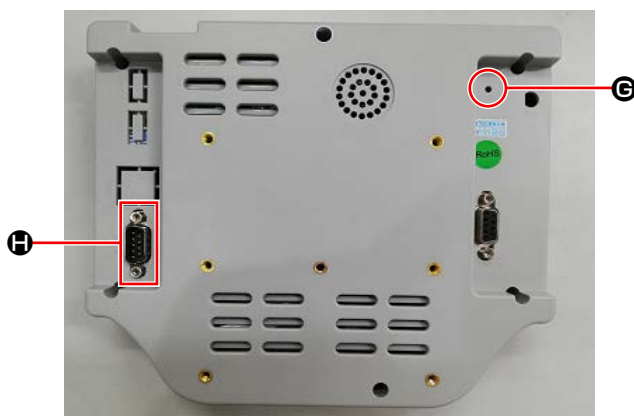

<b>G</b>	Reset button	Used to re-start the operation panel
<b>H</b>	COM port	RS232C

\* This product is not provided with the Wi-Fi function.

## Explanation of the operation panel screen

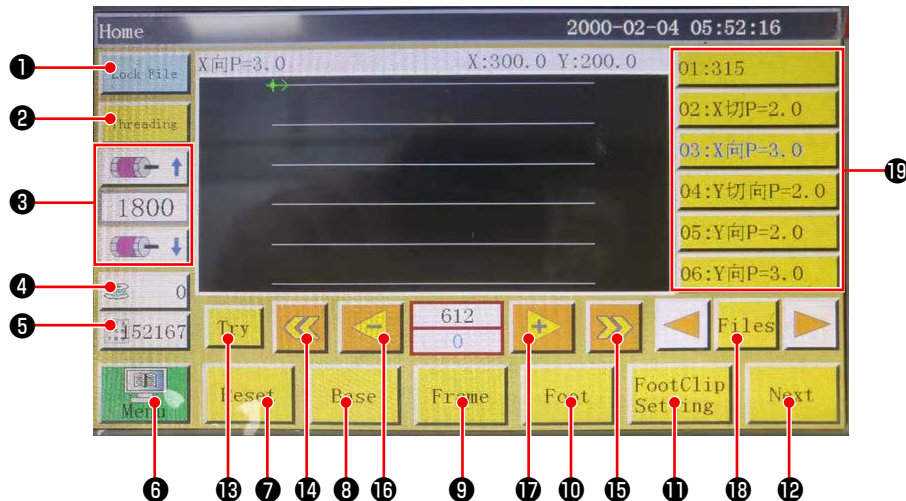

	Buttons / display	Description
①	Lock key	Used to lock the sewing pattern
②	Threading key	Used to thread the machine head
③	Main shaft speed change key	Used to change the sewing machine main shaft speed
④	Bobbin thread usage key	Used to display the amount of use of the bobbin thread and to move the screen to the setting screen *1
⑤	Sewing count key	Used to display the sewing count and to move the screen to the setting screen *1
⑥	Menu	Used to move the screen to the menu screen *1
⑦	Ready key	Used to return the sewing machine to its origin
⑧	Reference setting key	Used to move the screen to the reference setting screen *1
⑨	Cassette holder key	Used to move the cassette holder
⑩	Presser foot key	Used to operate the presser foot
⑪	Presser foot setting key	Used to move the screen to the presser foot setting screen *1
⑫	Page move key	Used to move the screen to the test mode screen *1
⑬	Test key	Used to operate the sewing pattern by jumping
⑭	Line segment return key	Used to return the sewing machine to the starting position of the previous continuous sewing by jumping
⑮	Line segment feed key	Used to feed the sewing machine to the starting position of the next continuous sewing by jumping
⑯	Single stitch return key	Used to return the sewing machine to the previous stitch. If this key is held pressed, fast-backward mode starts
⑰	Single stitch feed key	Used to feed the sewing machine to the next stitch. If this key is held pressed, fast-forward mode starts
⑱	File key	Used to move the screen to the sewing pattern selection screen
⑲	Sewing pattern selection	Select the sewing pattern to be used by touching it

\*1. Refer to the Instruction Manual for the operation panel for details.

## 4-24. Maintenance mode

The maintenance mode is the mode under which the notice telling that the duration of use of the sewing machine has reached the time requiring maintenance is provided in order to extend the product life of the sewing machine. Under this mode, the maintenance screen is displayed on the operation panel. When the maintenance staff enters the user password, the maintenance screen is erased.

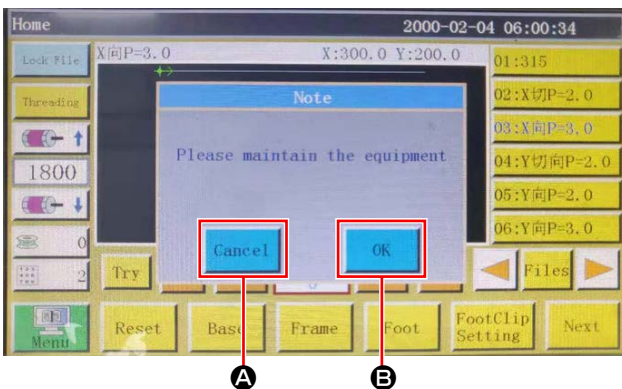
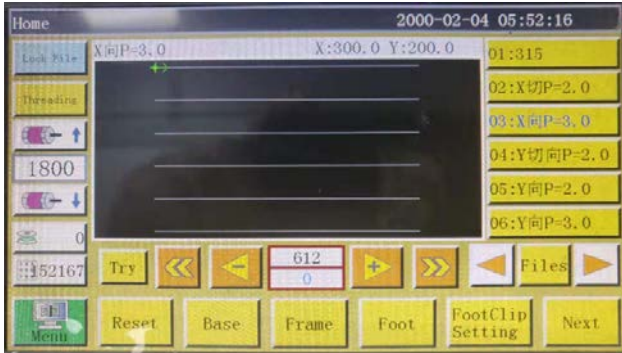

- 1) The maintenance screen is displayed when the time at which the sewing machine requires maintenance has come. (Approximately once every three months)

When cancel button **A** is pressed, the maintenance screen returns to the sewing screen. However, the maintenance screen is re-displayed one hour later.

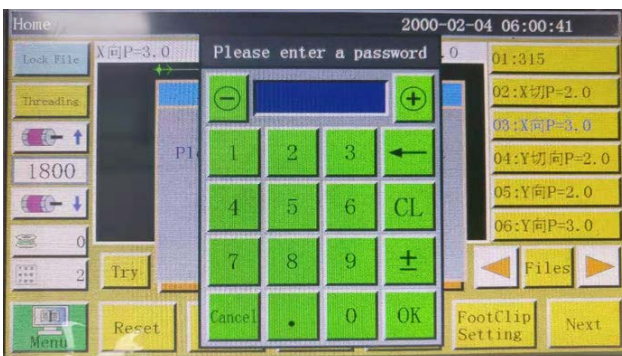

- 2) When enter button **B** is pressed, the user password input screen is displayed provided that the user password has been set up in prior.

- 3) Add grease referring to **"5. MAINTENANCE OF SAWING MACHINE" p.64.**

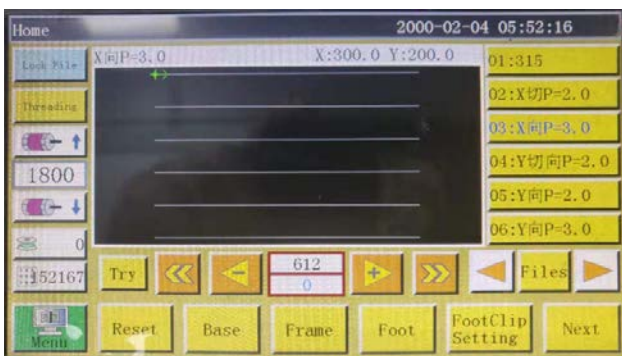

- 4) Enter the user password. Then, the maintenance screen returns to the sewing screen.

#### 4-25. List of parameters

Classification of parameters	No.	Parameter name	Range	Standard value	Meaning of parameter and comment
Automatic machining	P1	Clamp is opened after the completion of automatic machining	Yes/No	Yes	Cassette clamp is lifted every time the continuous sewing cycle is completed
	P2	Number of stitches to be sewn at the beginning and end of sewing with the intermediate presser lowered	0 to 8	2	Number of stitches during which the intermediate presser presses the material at the beginning and end of sewing
	P3	Thread trimming after the completion of automatic machining	Yes/No	Yes	Thread trimming is carried out every time the continuous sewing cycle is completed.
	P4	Position to which the needle is returned after the completion of automatic machining	Origin / secondary origin	Origin	"Origin" is the origin of absolute coordinates.
					"Secondary origin" is the secondary origin (offset point) added to the pattern.
	P5	Whether or not the thread tension is required to be lowered	Yes/No	No	Whether or not the tension on the thread is loosened during jump
	P173	Clamp foot is retained when setting a reference	Yes/No	No	The clamp foot is retained while a reference is being set. On the "Main screen", keep the clamp foot held at its current position while moving the shaft. (Lifted or lowered) The "Main screen" is displayed after the operation panel is started up.
	P259	Automatic operation of the clamp	Yes/No	No	Whether the cassette clamp is turned ON at the beginning of sewing
	P240	Clamp operation in prior to the manual feed	Yes/No	No	Whether the cassette clamp is turned ON before the manual feed is carried out
	P6	Number of stitches to be sewn with overlapped at the beginning of sewing	OFF / 1 / 2	OFF	In the case of set value "1" or "2", sewing is carried out once or twice in repetition at the first needle entry position before proceeding to the next needle entry position at the time of starting the sewing machine. Setting of the number of reverse feed stitches at the beginning of sewing
					In the case of "OFF", the sewing machine does not repeat sewing
	P7	Number of stitches to be sewn at the beginning of sewing without the thread tension release mechanism	0 to 255	0	The thread tension release mechanism is turned OFF while the sewing machine sews the set number of stitches at the beginning of sewing
P147	Height of the intermediate presser when it is lowered at the beginning of sewing	0 to 4	0.5	Intermediate presser height at the beginning of sewing	
P148	Height of the intermediate presser when it is lowered at the end of sewing	0 to 4	0.5	Intermediate presser height at the end of sewing	

Classification of parameters	No.	Parameter name	Range	Standard value	Meaning of parameter and comment
Automatic machining	P161	Setting of the oscillating width of the presser foot at the beginning and end of sewing	Normal / half cut / increase	Normal	
	P172	Intermediate presser is reset after the completion of operation	Yes/No	Yes	Intermediate presser motor is reset at the end of sewing
	P248	Whether or not the shaft travel is required before setting a reference	Yes/No	Yes	
	P252	Clamp opening error at the time of setting a reference	Yes/No	No	
	P794	Output IO 1 at the end of operation	Yes/No	No	
	P796		High/Low	Low	
	P795	Output IO 2 at the end of operation	Yes/No	No	
	P797		High/Low	Low	
Startup speed	P8	First stitch startup speed (r/min)	100 to 3000	300	First stitch sewing speed
	P9	Second stitch startup speed (r/min)	100 to 3000	600	Second stitch sewing speed
	P10	Third stitch startup speed (r/min)	100 to 3000	900	Third stitch sewing speed
	P11	4th stitch startup speed (r/min)	100 to 3000	1500	4th stitch sewing speed
	P12	5th stitch startup speed (r/min)	100 to 3000	2100	5th stitch sewing speed
	P170	Number of revolutions of the reverse feed stitching (r/min)	100 to 3000	1200	Reverse feed stitching speed
	P13	Whether or not the soft start is required	Yes/No	Yes	Whether the machine is started at a low speed
	P162	Whether or not the soft start is required for the second stitch at the beginning of sewing	Yes/No	No	Whether the second stitch is sewn at a low speed
	P163	Whether or not the sewing speed reduction is required for two stitches at the end of sewing	Yes/No	No	Two stitches at the end of sewing are sewn at a low speed
	Speed parameter	P14	Maximum number of revolutions of the main shaft (r/min)	100 to 3000	S: 3000 H: 1800
P15		Jump speed (mm/min)	100 to 40000	20000	Jump speed
P916		Inching speed of the feed (mm/min)	100 to 20000	5000	Travel speed during correction and creation of patterns
P160		Trial stitching speed (mm/min)	100 to 60000	8000	Demonstration speed
P17		Button sewing speed 1 after the button is pressed (mm/min)	100 to 20000	500	Eight direction keys support the case of manual movement of the box or collection of files
					Operation speed using ► icon
P18		Button sewing speed 2 after the button is pressed (mm/min)	100 to 20000	1500	Eight direction keys are supported
	Operation speed using ►► icon				

Classification of parameters	No.	Parameter name	Range	Standard value	Meaning of parameter and comment
Speed parameter	P19	Button sewing speed 3 after the button is pressed (mm/min)	100 to 20000	8000	Eight direction keys are supported Operation speed using ►►► icon
	P174	Machine head 2 speed (mm/s)	0 to 2000	0	XY axes speed when using a laser knife
	P175	Machine head 3 speed (mm/s)	0 to 2000	0	XY axes speed when using a laser knife
	P178	Continuous inching speed	Reduce / minimum / normal	Reduce	Travel speed during pattern creation
	P773	Number of revolutions in the reverse direction (r/min)	0 to 3000	0	Reverse feed stitching speed
	P774	Number of stitches to be sewn at a limited speed at the end of sewing	0 to 30	0	Setting of the number of stitch from which the sewing speed is limited at the end of sewing a pattern
	P775	Limited sewing speed to be employed at the end of sewing	100 to 1800	0	This parameter is used in combination with P774 to obtain the specific limited speed value.
Clamp setting	P22	Prohibition of sewing during lifting of the clamp	Yes/No	Yes	Prohibition of sewing during lifting of the cassette clamp
	P25	Thread clamp starting angle at the beginning of sewing	1 to 990	10	Thread clamp ON angle at the beginning of sewing
	P26	Thread clamp ending angle at the beginning of sewing	1 to 990	10	Thread clamp OFF angle at the beginning of sewing
	P27	Thread clamp starting angle during thread trimming	1 to 990	15	Thread clamp starting angle during thread trimming
	P28	Thread clamp ending angle during thread trimming	1 to 990	180	Thread clamp ending angle during thread trimming
	P781	Whether or not the clamp is required during travel	Yes/No	No	
	P743	Delay in opening of the double clamp (ms)	0 to 5000	0	
	P744	Delay in lowering of the double clamp (ms)	0 to 5000	0	
Bobbin winder setting	P29	Bobbin winder status	Allowed / prohibited	Allowed	Bobbin winder  允许 Default state
	P30	Winding speed (r/min)	100 to 4500	2200	Bobbin winding speed
	P31	Bobbin winding time setting (s)	1 to 63000	200	Time setting of bobbin winding
Reset setting	P36	Clamp at the time of resetting	Yes/No	No	Cassette clamp comes down when returning to origin
	P264	Clamp is opened after manual resetting	Yes/No	Yes	Cassette clamp goes up when returning to origin by pressing the reset button
	P38	Return-to-origin method	XY simultaneous / X preference / Y preference	XY simultaneous	"xy simultaneous" means that the x and y axes are simultaneously reset to their origins. "x preference" means that the x axis is firstly reset to the origin, and "y preference" means that the y axis is firstly reset to the origin.

Classification of parameters	No.	Parameter name	Range	Standard value	Meaning of parameter and comment
Reset setting	P39	Return-to-origin speed (mm/min)	100 to 60000	15000	x, y axes speed during resetting to the origin
	P756-P761	Output I/O setting before resetting	OUT1 to OUT6 / Not set	Not set	Setting of IO before resetting
	P762-P797		High level / low level	High level	
	P649	Alarm in the case of a resetting error	Yes/No	No	
	P782-P787	Output IO setting after resetting	OUT1 to OUT6 / Not set	Not set	Setting of IO after returning to the origin
	P788-P793		High level / low level	Low level	
Setting of stop	P40	Automatic thread trimming during temporary stop	Yes/No	Yes	Whether automatic thread trimming is performed at temporary stop
	P41	Needle position during temporary stop	Upper stop position / Lower stop position	Upper stop position	Needle bar position when temporary stop
	P45	Temporary stop switch type	Self lock / Normal	Self lock	Soft type of temporary stop, self-locking and normal
					"Normal" automatically bounces when touched
P799	Presser foot is not lifted during temporary stop	Yes/No	No		
Statistics settings	P49	Bobbin thread remaining amount is cleared at the time of turning the power ON	Yes/No	No	Whether the remaining amount of bobbin thread is reset to 0 (zero) when turning the power ON
	P50	Operation stops after the bobbin thread has run out	Yes/No	Yes	In the case of "Yes", the sewing machine stops when the consumed bobbin thread length has reached the "entire length".
	P51	Bobbin thread counter setting is enabled	Yes/No	Yes	In the case of "Yes", statistics automatically indicate the consumed bobbin thread length
	P46	Bobbin thread counter is cleared at the time of turning the power ON	Yes/No	Yes	Whether the sewing counter is reset to 0 (zero) when turning the power ON
	P47	Operation continues after the counter has reached the set value	Yes/No	Yes	Whether the operation is continued after the sewing counter has reached the set value
	P48	Counter setting is enabled	Yes/No	Yes	Whether the sewing counter is enabled
	P52	Working hours counter	Yes/No	Yes	In the case of "Yes", the machining time statistics function is enabled
	P779	Bobbin thread count mode	IN1 to IN4 / default	Default	Statics mode of the bobbin thread amount
	P780	Adjustment value of the surplus amount of bobbin thread (mm)	0 to 600000	0	Adjustment of the bobbin thread remaining amount



Classification of parameters	No.	Parameter name	Range	Standard value	Meaning of parameter and comment
Thread clamp setting	P54	Thread clamp position at the beginning of sewing	0 to 200	0	Thread clamp position at the beginning of sewing
	P236	Laser output IO	Yes/No	No	Laser output
	P693	Enabling automatically changeable hook	Yes/No	No	
Detection of thread breakage	P55	Automatic detection of thread breakage	Yes/No	Yes	In the case of "Yes", the operation is stopped and the description of error is displayed. Thread breakage detection function
	P56	Neglect of detection of thread breakage	Yes/No	Yes	In the case of "Yes", thread trimming is automatically carried out after detection thread breakage Thread breakage is followed by thread trimming
	P57	Detection is ignored for the set number of stitches during sewing	1 to 255	3	For the number of stitches firstly set, thread breakage will not be detected
	P58	Detection of the effective number of stitches in the case of thread breakage	1 to 255	2	In the case thread breakage is detected continuously to reach the specified maximum number of broken stitches, it is assumed that thread has broken definitely.
	P237	Thread breakage output IO	Yes/No	No	
Thread breakage setting	P60	The number of revolutions of the thread trimmer main shaft (r/min)	10 to 2000	260	Thread trimmer main shaft speed
	P61	Delay in the start of thread trimmer (s)	0.01 to 6.55	0.01	Delay time at the start of thread trimming
	P62	Continuous operating time of the wiper (s)	0.01 to 6.55	0.15	Wiper operating time
	P63	Delay in the lifting of presser foot after turning OFF the wiper (s)	0.01 to 6.55	0.25	Wiper OFF delay time
	P65	Whether or not the thread is trimmed during jump after sewing	Yes/No	Yes	Whether thread is trimmed at the time of jump
	P66	Whether or not the wiper is used	Yes/No	Yes	Whether the wiper is used
	P169	Thread slackening start mode	Angle / delay	Angle	Starting timing method for turning OFF the thread tension release mechanism
	P168	Thread slackening angle	0 to 999	850	Thread tension release mechanism turning-OFF angle
Energization setting	P70	The sewing machine is returned to the "stop with its needle up" state at the time of turning the power ON	Yes/No	Yes	Needle bar is at upper position when turning the power ON
	P71	Clamp is automatically returned to its origin at the time of turning the power ON	Yes/No	No	Cassette automatically returns to its origin when turning the power ON
	P73	Presser foot is lifted at the time of turning the power ON	Yes/No	Yes	Presser foot goes up when turning the power ON

Classification of parameters	No.	Parameter name	Range	Standard value	Meaning of parameter and comment
Other settings	P74	Whether or not the air pressure detection is required	Yes/No	No	In the case of "Yes", the sewing machine stops and generates the alarm if the detected air pressure is low during work
	P75	Whether or not the repetitive operation is required	Yes/No	No	"Yes" means that cyclic machining of the same file is started after turning the power ON
	P76	Repetitive machining time (min)	1 to 65535	1440	Cyclic machining total time: When the set time has elapsed, cyclic machining is stopped
Other settings	P77	Repetitive machining interval (s)	0 to 20	2	Interval from the completion of machining to re-starting of machining under the cyclic machining mode
	P78	Work ending position	Return to 0 (zero) / sewing starting position / default	Return to 0 (zero)	Return to 0 (zero): All of x / y axes coordinates return to 0 (zero); sewing machine terminates sewing; reset point
					Right side: Rightmost position within the machining range
					Sewing starting position: First sewing point of the machining file
	P395	Template recognition method	Barcode / electronic tag	Electronic tag	By serial number of file: Barcode identification mode
					By file name: Electronic tag identification mode
	P81	Interface style	Classic / simple	Classic	Classic: Button style of the virtual body
					Simple: Flat button style
	P681	Motion mode is started before operation	XY simultaneous / X precedence / Y precedence	XY simultaneous	
	P755	Jump mode during operation	X precedence / Y precedence / XY simultaneous	X precedence	Jump travel mode
P241	Connection to the extended screen	Yes/No	No	In the case of "Use", information on the operation file can be displayed on the external add-on display	
P79	Reverse feed after main shaft needle stops	0 to 160	0		
P242	Voice prompt	High / medium / low / OFF	OFF	"High", "medium" and "low" respectively refer to the magnitude of sound	
P21	Enabling the memory function during power failure	Enable / disable	Enable	After re-energization of the sewing machine, the sewing sequence carried out before power failure is resumed to continue sewing from that interrupted sequence.	
P194	The file is enabled upon separation of the electronic label	Enable / disable	Disable		

## 4-26. List of error codes

Error Code	Error description	Fault Cause	Solution
E001	There is no reset	The machine is not reset or reset abnormally after power on	Click the "Reset" button to reset
E002	Couldn't find X zero signal	<ol style="list-style-type: none"> <li>1. X-axis limit sensor is bad or wiring is bad</li> <li>2. The sensor or baffle screws are loose, or the mechanical jam causes the sensor not to be moved.</li> <li>3. Parameter errors, such as X-axis reset direction, polarity, platen size, etc.</li> </ol>	<ol style="list-style-type: none"> <li>1. Check the sensor wiring, manually trigger the sensor, and see if there is any change in the "input test" X limit text on the screen. Replace without change</li> <li>2. Check the structure</li> <li>3. Reset or redirect parameters</li> </ol>
E003	Couldn't find Y zero signal		Refer to <a href="#">E002</a> Error Handling Method
E004	Couldn't find Z zero signal		Refer to <a href="#">E002</a> Error Handling Method
E005	Couldn't find U zero signal		Refer to <a href="#">E002</a> Error Handling Method
E006	Couldn't find Extend zero signal		Refer to <a href="#">E002</a> Error Handling Method
E007	Spindle without internal zero signal	<ol style="list-style-type: none"> <li>1. Spindle encoder wiring is bad</li> <li>2. The spindle encoder is damaged</li> <li>3. Power board is broken</li> <li>4. The motor is broken</li> </ol>	<ol style="list-style-type: none"> <li>1. Check the wiring of the spindle encoder</li> <li>2. Replace the spindle motor</li> <li>3. Replace the power board</li> <li>4. Replace the motor</li> </ol>
E020	X axis overvoltage	<ol style="list-style-type: none"> <li>1. Overload when the load is too heavy and the idling speed is too fast to stop</li> <li>2. The main board or power board is broken, and the X axis detection voltage exceeds 92V.</li> </ol>	<ol style="list-style-type: none"> <li>1. Decrease the idling speed</li> <li>2. Screen menu auxiliary settings drive preview internal drive preview look at the current voltage of the XZ axis, if it is not between 80 92V, it means that the power board is faulty, you need to replace the power board. If one of them is within this range, it means the motherboard Bad need to change the motherboard.</li> </ol>
E021	X axis undervoltage	<ol style="list-style-type: none"> <li>1. The mains voltage is too low</li> <li>2. Power board failure</li> </ol>	<ol style="list-style-type: none"> <li>1. Check whether the voltage of the X axis driver is lower than 180V, and see if there are high power devices around the device that start and stop frequently; equipped with a voltage stabilizer according to the situation.</li> <li>2. Replace the power board</li> </ol>
E022	X axis hardware over current	<ol style="list-style-type: none"> <li>1. The X axis motor is broken or the motor wire is broken and short circuited</li> <li>2. The motherboard is broken</li> </ol>	<ol style="list-style-type: none"> <li>1. Replace the motor</li> <li>2. Replace the motherboard</li> </ol>

Error Code	Error description	Fault Cause	Solution
E023	X axis driver software over-current	<ol style="list-style-type: none"> <li>1. The parameters are incorrect</li> <li>2. The motor is stuck</li> <li>3. The motor is broken or the motor wire is damaged and short circuited</li> <li>4. The power board is damaged</li> </ol>	<ol style="list-style-type: none"> <li>1. Reset or redirect parameters</li> <li>2. Check the machinery</li> <li>3. Check and replace the motor</li> <li>4. Replace the power board</li> </ol>
E024	X axis encoder failure	<ol style="list-style-type: none"> <li>1. It is reported as too fast when it is moving.</li> <li>2. Poor or damaged contact of the encoder cable</li> <li>3. The machine is stuck causing the motor to turn</li> <li>4. Motherboard is broken</li> <li>5. The motor is broken</li> </ol>	<ol style="list-style-type: none"> <li>1. Decrease the idling speed</li> <li>2. Check the wiring or replace the motor</li> <li>3. Inspection machinery</li> <li>4. Replace the motherboard</li> <li>5. Replace the motor</li> </ol>
E025	X axis disconnected	<ol style="list-style-type: none"> <li>1. The motor plug is not inserted or has poor contact</li> <li>2. The motor wire is disconnected or damaged</li> <li>3. The motherboard is broken</li> </ol>	<ol style="list-style-type: none"> <li>1. Check the wiring</li> <li>2. Replace the motor</li> <li>3. Replace the motherboard</li> </ol>
E026	X axis overload	The X axis is overloaded	Lighten the load
E027	X axis position deviation is too large		Spare alarm
E028	X axis AD sampling module failure	<ol style="list-style-type: none"> <li>1. Abnormal startup</li> <li>2. The motherboard is damaged</li> </ol>	<ol style="list-style-type: none"> <li>1. Restart</li> <li>2. Replace the motherboard</li> </ol>
E029	X axis overheated	Drive overload	Lighten the load
E030	Y axis overvoltage		Refer to <a href="#">E020</a> Error Handling Method
E031	Y axis undervoltage		Refer to <a href="#">E021</a> Error Handling Method
E032	Y axis hardware over current		Refer to <a href="#">E022</a> Error Handling Method
E033	Y axis software over current		Refer to <a href="#">E023</a> Error Handling Method
E034	Y axis encoder failure		Refer to <a href="#">E024</a> Error Handling Method
E035	Y axis disconnected		Refer to <a href="#">E025</a> Error Handling Method
E036	Y axis overload		Refer to <a href="#">E026</a> Error Handling Method
E037	Y axis position deviation is too large		Spare alarm
E038	Y axis AD sampling module failure		Refer to <a href="#">E028</a> Error Handling Method
E039	Y axis overheated		Refer to <a href="#">E029</a> Error Handling Method
E040	Z axis overvoltage		Refer to <a href="#">E020</a> Error Handling Method
E041	Z axis undervoltage		Refer to <a href="#">E021</a> Error Handling Method
E042	Z axis hardware over current		Refer to <a href="#">E022</a> Error Handling Method
E043	Z axis software over current		Refer to <a href="#">E023</a> Error Handling Method
E044	Z axis encoder failure		Refer to <a href="#">E024</a> Error Handling Method
E045	Z axis disconnected		Refer to <a href="#">E025</a> Error Handling Method
E046	Z axis overload		Refer to <a href="#">E026</a> Error Handling Method
E047	Z axis position deviation is too large		Spare alarm

Error Code	Error description	Fault Cause	Solution
E048	Z axis AD sampling module failure		Refer to <a href="#">E028</a> Error Handling Method
E049	Z axis overheated		Refer to <a href="#">E029</a> Error Handling Method
E050	Shear driver overvoltage		Refer to <a href="#">E020</a> Error Handling Method
E051	Shear driver undervoltage	<ol style="list-style-type: none"> <li>1.XY axis idling speed is too fast when stopping</li> <li>2.The trimming module or power board is broken.</li> </ol>	<ol style="list-style-type: none"> <li>1. Check whether the voltage of the thread trimmer shaft drive is lower than 180V, and see if there are high power devices around the device that start and stop frequently; a voltage stabilizer is provided as appropriate.</li> <li>2. Replace the power board</li> </ol>
E052	Shear driver hardware over current		Refer to <a href="#">E022</a> Error Handling Method
E053	Shear driver software over current		Refer to <a href="#">E023</a> Error Handling Method
E054	Shear driver encoder failure		Refer to <a href="#">E024</a> Error Handling Method
E055	Shear driver open circuit	<ol style="list-style-type: none"> <li>1. Poor contact of motor seat</li> <li>2. The motor wire is disconnected or damaged</li> <li>3. The thread trimming module is broken</li> </ol>	<ol style="list-style-type: none"> <li>1. Check the wiring</li> <li>2. Replace the motor</li> <li>3. Replace the thread trimming module</li> </ol>
E056	Shear driver overload		Refer to <a href="#">E026</a> Error Handling Method
E057	Shear driver position difference		Refer to <a href="#">E027</a> Error Handling Method
E058	Shear driver AD sampling failure		Refer to <a href="#">E028</a> Error Handling Method
E059	Shear driver overheated		Refer to <a href="#">E029</a> Error Handling Method
E060	Main axis overvoltage	<ol style="list-style-type: none"> <li>1. The mains voltage is too high</li> <li>2. Power board failure</li> </ol>	<ol style="list-style-type: none"> <li>1. Check the internal drive to preview whether the spindle voltage is higher than 400V, check whether the AC power supply voltage fluctuates abnormally, and see if there are high power equipment around the equipment that frequently start and stop; equipped with a voltage regulator as appropriate.</li> <li>2. Replace the power board</li> </ol>
E061	Main axis undervoltage	<ol style="list-style-type: none"> <li>1. The mains voltage is too low</li> <li>2. Power board failure</li> </ol>	<ol style="list-style-type: none"> <li>1. Check whether the internal drive previews the spindle voltage lower than 180V, and see if there are high power devices around the device that frequently start and stop; equipped with a voltage regulator as appropriate.</li> <li>2. Replace the power board</li> </ol>
E062	Main axis hardware over current	<ol style="list-style-type: none"> <li>1. The X axis motor is broken or the motor wire is damaged and short circuited</li> <li>2. The motherboard is damaged</li> </ol>	<ol style="list-style-type: none"> <li>1. Replace the motor</li> <li>2. Replace the motherboard</li> </ol>

Error Code	Error description	Fault Cause	Solution
E063	Main axis software over current	1. The parameters are incorrect. 2. The motor is stuck 3. The motor is broken or the motor wire is broken and short circuited 4. Power board is broken	1. Reset or redirect parameters 2. Check the machinery 3. Check and replace the motor 4. Replace the power board
E064	Main axis encoder failure	1. Poor encoder wiring 2. The encoder is damaged	1. Check the motor encoder wiring 2. Replace the spindle motor
E065	Main axis locked rotor	1. The load is too heavy 2. The spindle is mechanically stuck	1. Lighten the load 2. Check the machine
E066	Main axis detection for locked rotor	The spindle load is too large	Check the spindle mechanical structure for problems
E067	Y servo hardware protection	1. The motor is broken or the motor wire is broken and short circuited 2. The motor is stuck 3. Y servo board is broken 4. The parameters are incorrect	1. Check and replace the motor 2. Check the machinery 3. Replace Y servo board 4. Reset or redirect parameters
E068	Y servo HOC		Spare alarm
E069	Y servo AD module initial correction fault		Refer to <a href="#">E028</a> Error Handling Method
E070	Y servo parameter storage exception	Abnormal memory chip	Replace the chip
E071	Y servo system parameter is abnormal	Parameter configuration error	Check parameter configuration
E072	Y Servo Ad sampling module failure		Refer to <a href="#">E028</a> Error Handling Method
E073	Y servo encoder disconnected	1. Y servo encoder has poor contact or disconnection 2. Y servo motor is broken 3. Y servo board is broken	1. Check the Y servo encoder line 2. Replace Y servo motor 3. Replace Y servo board
E074	Y servo encoder AB interference	1. The Y servo board program is the old version 2. Poor contact or broken wire of the servo encoder	1. Look at the screen "Internal Drive" - "Y "Version Number", 1 means the old version needs to be returned to the factory to update the program 2. Check the encoder cable
E075	Y servo encoder Z interference		Refer to <a href="#">E074</a> Error Handling Method
E076	Y servo bus undervoltage		Refer to <a href="#">E410</a> Error Handling Method
E077	Y servo software over current		Spare alarm
E078	Y servo motor overload		Refer to <a href="#">E023</a> Error Handling Method
E079	Y servo motor overload		Refer to <a href="#">E026</a> Error Handling Method
E080	Y servo driver overload		Refer to <a href="#">E026</a> Error Handling Method
E081	Y servo motor overheated	Motor overload	Lighten the load
E082	Y servo drive overheated		Refer to <a href="#">E029</a> Error Handling Method
E083	Y servo fan is abnormal		Spare alarm

Error Code	Error description	Fault Cause	Solution
E084	Y servo overspeed	<ol style="list-style-type: none"> <li>1. The wiring of the cable and encoder cable is wrong</li> <li>2. The pulse frequency output by the controller is too large</li> <li>3. The electronic gear ratio is too large</li> <li>4. The servo gain setting is too large</li> </ol>	<ol style="list-style-type: none"> <li>1. Whether the wiring of the servo motor power cable and encoder cable is correct and damaged</li> <li>2. The pulse frequency output by the controller is too large</li> <li>3. Reduce electronic gear ratio</li> <li>4. Try to adjust the servo gain manually or automatically again</li> </ol>
E085	Y Servo position deviation is too large	<ol style="list-style-type: none"> <li>1. Y servo board program is an old version</li> <li>2. Mechanical stuck</li> </ol>	<ol style="list-style-type: none"> <li>1. See "Internal Driver" - "Y Servo" on the screen No version number indicates that the old version needs to be returned to the factory to update the program.</li> <li>2. Check the machinery</li> </ol>
E086	Y servo bus voltage phase failure	<ol style="list-style-type: none"> <li>1. Poor motor wiring</li> <li>2. The motor is damaged</li> <li>3. The Y servo board is damaged</li> </ol>	<ol style="list-style-type: none"> <li>1. Check the motor wiring</li> <li>2. Replace the motor</li> <li>3. Replace the Y servo board</li> </ol>
E087	Y servo motor phase sequence error	Incorrect wiring phase sequence	Wiring in the correct phase sequence
E088	Y servo driver Rated current input error		Spare alarm
E089	Y servo brake resistor overload		Spare alarm
E090	Y servo absolute encoder overheat		Spare alarm
E091	Low voltage of Y servo battery	Battery exhausted	Replacement battery
E092	Y servo position information lost		Spare alarm
E093	Y servo drive and motor mismatch	Motor model does not match	Replace the servo motor
E094	Y servo origin regression failure	<ol style="list-style-type: none"> <li>1. There is a problem with the encoder</li> <li>2. There is a problem with the direction of the drive</li> <li>3. The pulse current limiting resistance is large</li> </ol>	<ol style="list-style-type: none"> <li>1. Overhaul the encoder</li> <li>2. Overhaul the drive direction</li> <li>3. Lower the power supply voltage</li> </ol>
E095	Y servo main power supply power off		Spare alarm
E096	Learning failure of Y servo offset angle		Spare alarm
E097	Y servo power break restart	<ol style="list-style-type: none"> <li>1. Excessive load</li> <li>2. Overheat protection</li> <li>3. The screw or nut is damaged</li> </ol>	<ol style="list-style-type: none"> <li>1. Reduced load operation</li> <li>2. Cooling treatment</li> <li>3. Maintenance accessories</li> </ol>
E098	Y servo initializes LAN9252 error		Spare alarm
E099	Y servo DSP and ESC communication interrupted		Spare alarm
E100	Y servo interrupts communication with host through network cable		Spare alarm

Error Code	Error description	Fault Cause	Solution
E101	Y servo PDO parameters read only		Spare alarm
E102	Y Servo PDO does not have an index to find		Spare alarm
E103	Y servo PDO setting synchronization time out of range		Spare alarm
E104	Y servo PDO data out of range		Spare alarm
E105	Y servo UVW ground fault	1. Wrong phase sequence 2. The power supply voltage is too high	1. Adjust the phase sequence 2. Lower the power supply voltage
E106	Y servo inertia identification failed		Spare alarm
E107	Y servo encoder EEPROM read and write failed		Spare alarm
E108	Y servo position positive limit		Spare alarm
E109	Y servo position negative limit		Spare alarm
E110	Y servo electronic gear ratio setting range is wrong		Spare alarm
E111	Y servo input pulse frequency too high error		Spare alarm
E112	Spindle hardware protection	1. The motor is broken or the motor wire is damaged and short circuited 2. The motor is stuck 3. The power board spindle module is damaged	1. Check and replace the motor 2. Check the machinery 3. Replace the power board
E113	Broken spindle encoder	1. Poor contact or broken wire of the spindle encoder 2. The spindle motor is damaged	1. Check the spindle encoder line 2. Replace the spindle motor
E114	Spindle encoder AB interference	1. The power board program is the old version 2. Poor contact or broken wire of the spindle encoder	1. Look at the screen "Internal Drive" - "Version Number", 1 means the old version needs to be returned to the factory to update the program 2. Check the encoder cable
E115	Spindle encoder Z interference		Refer to <a href="#">E114</a> Error Handling Method
E116	Spindle multi turn data out of range		Refer to <a href="#">E092</a> Error Handling Method
E117	Spindle absolute encoder overheating		Refer to <a href="#">E090</a> Error Handling Method
E118	Spindle battery voltage is too low		Refer to <a href="#">E091</a> Error Handling Method
E119	Spindle multi turn position is missing		Spare alarm
E120	Spindle motor overload		Refer to <a href="#">E026</a> Error Handling Method



Error Code	Error description	Fault Cause	Solution
E121	Overload of spindle drive		Refer to <a href="#">E026</a> Error Handling Method
E122	Spindle braking resistor overload		Refer to <a href="#">E089</a> Error Handling Method
E123	Overheated spindle motor		Refer to <a href="#">E415</a> Error Handling Method
E124	Overheated spindle drive		Refer to <a href="#">E416</a> Error Handling Method
E125	Undervoltage of spindle bus		Refer to <a href="#">E410</a> Error Handling Method
E126	Spindle busbar overpressure		Spare alarm
E127	Spindle main power off		Spare alarm
E128	Spindle software overcurrent		Refer to <a href="#">E412</a> Error Handling Method
E129	Spindle position forward limit		Spare alarm
E130	Negative limit of spindle position		Spare alarm
E131	Spindle electronic gear ratio error		Spare alarm
E132	Spindle input pulse frequency is too high		Spare alarm
E133	Excessive spindle position deviation	<ol style="list-style-type: none"> <li>1. The spindle board program is the old version</li> <li>2. Mechanical stuck</li> </ol>	<ol style="list-style-type: none"> <li>1. "Internal drive" - "spindle" no version number means that the old version needs to be returned to the factory to update the program</li> <li>2. Check the machinery</li> </ol>
E134	Spindle overspeed	<ol style="list-style-type: none"> <li>1. Wiring error</li> <li>2. The acceleration is too high</li> <li>3. The grid voltage is too low</li> <li>4. Low spindle power</li> <li>5. Short circuit of spindle to ground</li> </ol>	<ol style="list-style-type: none"> <li>1. Check the line</li> <li>2. Reduce acceleration</li> <li>3. Check the input power</li> <li>4. Select a spindle with a large power level</li> <li>5. Check whether the spindle is short circuited to ground</li> </ol>
E135	Principal axis origin return failed		Spare alarm
E136	Phase loss of spindle bus voltage		Spare alarm
E137	Phase sequence error of spindle motor	Reverse phase sequence	Measure with a multimeter to restore the correct phase sequence
E138	UVW short to ground		Refer to E105 Error Handling Method
E200	XY driver alarm	<ol style="list-style-type: none"> <li>1. The driver wiring is bad</li> <li>2. The drive is damaged</li> </ol>	<ol style="list-style-type: none"> <li>1. Check the wiring</li> <li>2. Replace the motherboard</li> </ol>
E201	X driver alarm		Refer to <a href="#">E200</a> Error Handling Method
E202	Y driver alarm		Refer to <a href="#">E200</a> Error Handling Method

Error Code	Error description	Fault Cause	Solution
E203	The main motor error	<ol style="list-style-type: none"> <li>1. The winding is normal but the work occasionally reports that the power board software and hardware are too old</li> <li>2. The spindle is stuck</li> <li>3. The parameters are incorrect, such as P665 to P668</li> <li>4. The spindle encoder cable is broken or has poor contact.</li> <li>5. The spindle motor is broken</li> <li>6. Power board or motherboard hardware is bad</li> <li>7. The motherboard and the power board connected to the dress rehearsal line poor contact</li> </ol>	<ol style="list-style-type: none"> <li>1. See "Internal Drive Preview" - "Spindle" - "Version Number" on the screen. If it is lower than 2, you need to update the program.</li> <li>2. Manual rotation, check the machinery</li> <li>3. Reset or redirect parameters</li> <li>4. Check the wiring; manually turn around to see if the screen QEP changes one cycle, and see if the "spindle 0 bit level" changes once. If there is no change, it means that the encoder wire is broken or the motor is broken or the power board is broken.</li> <li>5. Replace the spindle motor</li> <li>6. Replace the power board or motherboard</li> <li>7. Check the connection cable</li> </ol>
E204	The main motor direction error	<ol style="list-style-type: none"> <li>1. The main motor direction parameter is set incorrectly.</li> <li>2. Occasionally reported as a power board failure</li> </ol>	<ol style="list-style-type: none"> <li>1. Change the main motor direction parameter in the software or screen</li> <li>2. Replace the power board</li> </ol>
E205	Pressure box didn't put down	The current frame is in the raised state	Click the "Frame" button to lower the press frame
E206	Failure of head board	<ol style="list-style-type: none"> <li>1. Bad head cable</li> <li>2. The head plate is damaged</li> <li>3. The motherboard is damaged</li> </ol>	<ol style="list-style-type: none"> <li>1. Check the headboard connection line</li> <li>2. Replace the head board</li> <li>3. Replace the motherboard</li> </ol>
E207	Input IO timeout error	<ol style="list-style-type: none"> <li>1. The corresponding input IO wiring or sensor is broken</li> <li>2. The corresponding input IO mechanism cannot be triggered</li> <li>3. Parameter or file setting error</li> <li>4. The sensor or PCB board where the corresponding IO is located is broken</li> </ol>	<ol style="list-style-type: none"> <li>1. Test wiring or sensor</li> <li>2. Check the mechanical structure</li> <li>3. Check or redirect parameters and processing files</li> <li>4. Confirm whether the corresponding IO can be triggered manually in the "input test" screen, if not, replace it.</li> </ol>
E208	Air pressure is insufficient	<ol style="list-style-type: none"> <li>1. Insufficient air pressure</li> <li>2. Pressure detection device failure</li> </ol>	<ol style="list-style-type: none"> <li>1. Check if the air supply is normal</li> <li>2. Check the air pressure detection device</li> </ol>
E209	Motor scissors are not in place	<ol style="list-style-type: none"> <li>1. The parameters are incorrect, such as the polarity of the thread trimming</li> <li>2. Poor or broken wiring of trimmer zero sensor</li> <li>3. The sensor or motor coupling is loose and offset</li> <li>4. Scissor motor is stuck</li> <li>5. Motor damage</li> <li>6. The motor corresponding driver board is broken</li> </ol>	<ol style="list-style-type: none"> <li>1. Reset parameters</li> <li>2. Check the wiring or replace the sensor</li> <li>3. Inspection machinery</li> <li>4. Check the scissors motor</li> <li>5. Replace the motor</li> <li>6. Replace the corresponding driver board</li> </ol>

Error Code	Error description	Fault Cause	Solution
E210	Motor foot fault	<ol style="list-style-type: none"> <li>1.Zero parameter setting error</li> <li>2.If it is an external zero position, the zero position sensor wiring is bad or damaged, or the installation is loose</li> <li>3.If it is the zero position of the motor encoder, the encoder line is defective or damaged.</li> <li>4.The presser foot mot or is stuck or the coupling is loose.</li> <li>5.Motor damage</li> <li>6.The motor corresponding driver board is broken</li> </ol>	<ol style="list-style-type: none"> <li>1.Change the zero parameter P687</li> <li>2.Check the wiring or replace the sensor</li> <li>3.Check the encoder line or replace the motor</li> <li>4.Check the mechanical structure</li> <li>5.Replace the motor</li> <li>6.Replace the corresponding driver board</li> </ol>
E211	Grab line motor is not in place		Check if the zero signal of the wire gripping motor is normal
E212	Cutters are not in place	<ol style="list-style-type: none"> <li>1.The sensor wiring is bad or damaged</li> <li>2.Sensor mounting position deviation</li> <li>3.The cutter motor is stuck or loose</li> <li>4.Parameter setting error</li> <li>5.Control cutter driver enable IO abnormal or gas valve failure</li> <li>6.Motor damage</li> <li>7.Bad control line or bad driver</li> </ol>	<ol style="list-style-type: none"> <li>1.Check the wiring or replace the sensor</li> <li>2.Adjust the sensor installation position</li> <li>3.Check the cutter motor</li> <li>4.Reset or redirect parameters</li> <li>5.Test cut to the corresponding IO function, such as lifting IO</li> <li>6.Replace the motor</li> <li>7.Check the line, replace the driver</li> </ol>
E213	Broken line	<ol style="list-style-type: none"> <li>1.The sewing thread is broken</li> <li>2.Disconnection detection device failure</li> <li>3.Parameter error</li> </ol>	<ol style="list-style-type: none"> <li>1.Thread the needle again</li> <li>2.Check the disconnection detection device, and confirm the sensor on the "input test" interface</li> <li>3.Reset parameters</li> </ol>
E214	The quantity of work is full	Prompt when "Current Piece Count" reaches "Total Piece Count" in processing statistics	<ol style="list-style-type: none"> <li>1.The current value of redesigned parts or the total number of piece counts</li> <li>2.If you don't need to count statistics, you can turn off the piece counting function in "Statistics Settings"</li> </ol>
E215	The bottom line has been used up	The "status used length" of the processing statistics interface is greater than or equal to "the total length of the bottom line"	<ol style="list-style-type: none"> <li>1.Need to change the bobbin hook and reset the corresponding total bobbin length.</li> <li>2.If you do not need to use the bottom line statistics, you can turn off this function in the "statistics settings"</li> </ol>
E216	The file is too large	The number of stitches of the graphics file exceeds the maximum range	Need to replace small graphics files
E217	No working file	<ol style="list-style-type: none"> <li>1.Under the lock file, if the electronic label does not scan the existing graphic name, press Start</li> <li>2.Screen and motherboard file transfer failure</li> </ol>	<ol style="list-style-type: none"> <li>1.Need to re scan or switch graphics files</li> <li>2.Check the screen cable and upgrade the motherboard and screen program</li> </ol>

Error Code	Error description	Fault Cause	Solution
E218	Waiting for the working data	<ol style="list-style-type: none"> <li>1. The file is too large, the motherboard waits for the screen to transfer files during processing</li> <li>2. The screen cable has poor contact or is disconnected.</li> <li>3. The screen line is tied with a strong interference source</li> <li>4. The screen or motherboard program is too old</li> <li>5. The screen or motherboard hardware is damaged</li> </ol>	<ol style="list-style-type: none"> <li>1. Need to wait for a while to disappear automatically</li> <li>2. Check the screen line</li> <li>3. Separate screen wires from strong interference wires such as motor power wires</li> <li>4 Upgrade the latest screen or motherboard program</li> <li>5. Test whether you can upgrade the motherboard program; test whether the communication is normal in the "Test Transmission" interface, and replace the hardware if it is abnormal</li> </ol>
E219	Electrical fault, please contact the manufacturer	Motherboard hardware exception	Contact equipment manufacturer
E220	Wrong upgrade file	<ol style="list-style-type: none"> <li>1. The upgrade file is not suitable for this system</li> <li>2. The upgrade file is damaged</li> </ol>	<ol style="list-style-type: none"> <li>1. Use the corresponding upgrade file, such as BP01 system can only upgrade BP01 program</li> <li>2. Confirm whether the upgrade file in the USB flash drive is damaged</li> </ol>
E221	Upgrade file type error	The upgrade file is corrupted or the upgrade file is not suitable for this system.	Need to select the corresponding type of upgrade file for upgrade
E222	Could not upgrade	Motherboard hardware exception	Contact equipment manufacturer
E223	Upgrade file not the same OEM manufacturer	Upgrade file version does not match	The system is not the corresponding legal upgrade file
E224	Head board can not be connected 1.The connection	<ol style="list-style-type: none"> <li>1. The connection between the head board and the motherboard is broken or the interface is loose.</li> <li>2. Headboard or motherboard hardware failure</li> </ol>	<ol style="list-style-type: none"> <li>1. Check the cable of the head board</li> <li>2. Replace the headboard or motherboard</li> </ol>
E225	Connecting the main control board...	<ol style="list-style-type: none"> <li>1. The screen cable interface is loose or damaged</li> <li>2. Screen or motherboard hardware failure</li> </ol>	<ol style="list-style-type: none"> <li>1. Check the screen cable for bad contact or damage</li> <li>2. Replace the screen or motherboard</li> </ol>
E226	Current file is invalid	<ol style="list-style-type: none"> <li>1. Upgrade without selecting the upgrade file</li> <li>2. The read file is damaged or of the wrong type</li> <li>3. U disk is incompatible or damaged</li> </ol>	<ol style="list-style-type: none"> <li>1. Insert U disk and select upgrade file</li> <li>2. Replace the correct documents</li> <li>3. Replace U disk</li> </ol>

Error Code	Error description	Fault Cause	Solution
E227	The file transfer failed	<ol style="list-style-type: none"> <li>1. The screen cable interface is loose or disconnected</li> <li>2. The screen or motherboard program is too old</li> <li>3. Screen or motherboard hardware failure</li> <li>4. The screen line is tied with a strong interference source</li> </ol>	<ol style="list-style-type: none"> <li>1. Check the screen line</li> <li>2. Upgrade the latest screen or motherboard program</li> <li>3. Test whether you can upgrade the motherboard program; test whether the communication is normal in the "Test Transmission" interface, and replace the hardware if it is abnormal</li> <li>4. Separate screen wires from strong interference wires such as motor power wires</li> </ol>
E228	Data outside the range	The current graphic file data exceeds the maximum format limit	Check if the graphic data is abnormal
E229	The modified Angle is too large	Single modification of graph angle value is too large	Decrease the modified angle value
E230	Loading graph data...	Processing necessary graphics data	Wait for a while before proceeding
E231	Foot follow error	<ol style="list-style-type: none"> <li>1. The presser foot motor is stuck when it rotates.</li> <li>2. Parameter setting error</li> </ol>	<ol style="list-style-type: none"> <li>1. Check if the presser foot motor is normal</li> <li>2. Reset parameters</li> </ol>
E232	No U disk!	<ol style="list-style-type: none"> <li>1. U disk is not inserted or damaged</li> <li>2. The screen U disk interface is damaged</li> </ol>	<ol style="list-style-type: none"> <li>1. Re insert U disk or replace U disk</li> <li>2. Insert other U disk interface or change screen</li> </ol>
E233	File error!	An error occurred while reading or writing from the USB flash drive	<ol style="list-style-type: none"> <li>1. Replace graphics files</li> <li>2. Re insert U disk or replace U disk</li> </ol>
E234	Graph or head offset out of bounds!	<ol style="list-style-type: none"> <li>1. The file size is too large to exceed the processable range</li> <li>2. The file is small but offset from the processable range</li> <li>3. Head offset is out of bounds</li> <li>4. The parameters are set incorrectly, such as the size of the pressure plate</li> </ol>	<ol style="list-style-type: none"> <li>1. Replace graphics with smaller height and width</li> <li>2. Reset the reference point position</li> <li>3. Reset the head offset value of head 2 or head 3.</li> <li>4. Set the platen size corresponding to the machine</li> </ol>
E235	This is not a working file!	File content or format error	Replace Recognizable Graphics File
E236	TF RAM error	Bad motherboard	Replace the motherboard
E237	Please set the admin password first	No administrative password is set	Need to set an administrative password first
E238	Editing is not supported	No editing instructions or files	No editing instructions or files
E239	Please contact the manufacturer	Contact the manufacturer	Contact equipment manufacturer
E240	Communication fault 2	<ol style="list-style-type: none"> <li>1. Bad communication or damage to the screen leads to CAN communication failure</li> <li>2. The screen or motherboard program is too old</li> <li>3. The screen or motherboard is broken</li> </ol>	<ol style="list-style-type: none"> <li>1. Check the screen line</li> <li>2. Upgrade the latest screen or motherboard program</li> <li>3. Replace the screen or motherboard</li> </ol>
E241	Time anomaly	Time is wrong	<ol style="list-style-type: none"> <li>1. The time is illegally modified</li> <li>2. The motherboard battery is low.</li> </ol>

Error Code	Error description	Fault Cause	Solution
E242	No work IO	<ol style="list-style-type: none"> <li>1. The work enable input IO signal is abnormal.</li> <li>2. Parameter setting error</li> </ol>	<ol style="list-style-type: none"> <li>1. Check the corresponding IO</li> <li>2. Turn off the "work enable input IO" function and set the parameter value to 0</li> </ol>
E243	Waiting for input IO	<ol style="list-style-type: none"> <li>1. Input IO signal in waiting file</li> <li>2. Corresponding input IO sensor has bad contact or is damaged or unable to trigger</li> <li>3. Parameter or file setting error</li> </ol>	<ol style="list-style-type: none"> <li>1. Automatically disappears when the corresponding IO is detected</li> <li>2. Check sensor failure</li> <li>3. Resetting parameters or processing files</li> </ol>
E244	Execution delay	<ol style="list-style-type: none"> <li>1. Execute the delay instruction in the graphics file</li> <li>2. The delay time is too long</li> </ol>	<ol style="list-style-type: none"> <li>1. It disappears automatically after completing the delay</li> <li>2. Reset delay as appropriate</li> </ol>
E245	The file name is too long	The file name written in the electronic tag is longer than 32 bytes (32 English or 16 Chinese characters)	Need to shorten the length of the file name before writing
E246	Please lift the presser foot first	Presser foot not raised	Click the "Presser Foot" button to raise the presser foot
E247	Frame is not pressed down	Unpressed frame	Click the "press frame" button to lower the frame
E248	Auxiliary frame is not pressed down	<ol style="list-style-type: none"> <li>1. Unpressed auxiliary pressure frame</li> <li>2. Parameter setting error</li> </ol>	<ol style="list-style-type: none"> <li>1. Click the corresponding IO button of the auxiliary pressure frame</li> <li>2. Reset parameters</li> </ol>
E249	Frame and auxiliary frame is not pressed down	<ol style="list-style-type: none"> <li>1. Unpressed frame and auxiliary frame</li> <li>2. Parameter setting error</li> </ol>	<ol style="list-style-type: none"> <li>1. Click the corresponding button to push down both the pressing frame and the auxiliary pressing frame.</li> <li>2. Reset parameters</li> </ol>
E250	Punched material has run out	Out of punching base material	Need to replace the new punch base material
E251	Reset failed	The reset fails due to various reasons, such as the origin cannot be found during reset	Go to "Auxiliary Settings" - "Test Transmission" - "Alarm Log" to see which alarms have occurred during this reset failure. Refer to the previous alarm faults to resolve these alarms and reset them.
E252	Rotating motor failure	<ol style="list-style-type: none"> <li>1. Rotary motor alarm due to mechanical overload, etc.</li> <li>2. The motor wire of the rotating motor is disconnected, the interface is loose, and the connection line between the motor and the driver is faulty.</li> <li>3. Rotary shaft driver is broken</li> <li>4. The rotating motor is broken</li> </ol>	<ol style="list-style-type: none"> <li>1. Check if the machine is stuck</li> <li>2. Check the corresponding wiring</li> <li>3. Replace the flashing drive</li> <li>4. Replace the motor</li> </ol>
E400	Drive board cannot be connected	Abnormal circuit of main board	Overhaul the motherboard circuit
E401	(0x) Drive board hardware protection	<ol style="list-style-type: none"> <li>1. The motor is broken or the motor wire is damaged and short circuited</li> <li>2. The motor is stuck</li> <li>3. The driver board is damaged</li> <li>4. The parameters are incorrect</li> </ol>	<ol style="list-style-type: none"> <li>1. Check and replace the motor</li> <li>2. Check the machinery</li> <li>3. Replace the Y servo board</li> <li>4. Reset or redirect parameters</li> </ol>

Error Code	Error description	Fault Cause	Solution
E402	(0x) Driver board HOC		Spare alarm
E403	(0x) Driver module AD module initial calibration failure		Spare alarm
E404	(0x) Drive board parameter storage error	1. Abnormal memory 2. Not enough memory	1. Maintenance memory 2. Expand memory or clear data
E405	(0x) Driver board system parameters are abnormal	There is a problem with the drive	Update drive
E406	(0x) Driver board AD sampling module is faulty		Refer to <b>E028</b> Error Handling Method
E407	(0x) The driver board encoder is disconnected	1. The encoder of the driver board is poorly connected or disconnected 2. The motor is damaged 3. The motherboard is damaged	1. Check the encoder cable of the driver board 2. Replace the motor 3. Replace the motherboard
E408	(0x) Driver board encoder AB interference	1. The driver program is an old version  2. Poor contact or broken wire of the servo encoder	1. Look at the screen "Internal Drive" - "Y Servo" - "Version Number", 1 means the old version needs to be returned to the factory to update the program 2. Check the encoder cable
E409	(0x) Driver board encoder Z interference		Refer to <b>E408</b> Error Handling Method
E410	(0x) Driver board bus undervoltage	1. Voltage drop 2. The bus load is too heavy 3. Transformer failure	1. Increase the voltage 2. Reduced load operation 3. Repair or replace the transformer
E411	(0x) Driver board bus overvoltage		Spare alarm
E412	(0x) Driver board software overcurrent		Refer to <b>E023</b> Error Handling Method
E413	(0x) Drive board motor overload		Refer to <b>E026</b> Error Handling Method
E414	(0x) Drive board drive overload	1. Excessive friction increases the operating load 2. Insufficient power or improper adjustment of internal parameters	1. Lubrication 2. Adjust the gain or adjust the parameters
E415	(0x) Driver board motor overheating		Spare alarm
E416	(0x) Driver board driver overheating		Refer to <b>E029</b> Error Handling Method
E417	(0x) Drive board fan error		Spare alarm
E418	(0x) Drive board overspeed	1. Wiring error 2. The acceleration is too high 3. The grid voltage is too low 4. The driver power is low 5. The driver is shorted to ground	1. Check the line 2. Reduce acceleration 3. Check the input power 4. Choose the driver with large power level 5. Check whether the drive is short circuited to ground

Error Code	Error description	Fault Cause	Solution
E419	(0x) Driver board position deviation is too large	<ol style="list-style-type: none"> <li>1. The position deviation parameter is set too small</li> <li>2. Servo unit circuit board failure</li> <li>3. UVW wiring of the servo motor is abnormal (wire missing)</li> <li>4. Poor gain adjustment of the servo unit</li> <li>5. The frequency of the position command pulse is too high</li> <li>6. The load conditions do not match the specifications of the motor</li> </ol>	<ol style="list-style-type: none"> <li>1. Reset the correct parameters</li> <li>2. Replace the servo unit</li> <li>3. Correct the motor (encoder) wiring</li> <li>4. Increase the speed loop gain and position loop gain</li> <li>5. Slowly reduce the position command frequency; add smooth function; re-evaluate the electronic gear ratio</li> <li>6. Re-evaluate the load or motor capacity</li> </ol>
E420	(0x) Driver board bus voltage phase loss		Refer to <a href="#">E086</a> Error Handling Method
E421	(0x) Drive board motor phase sequence error	Reverse phase sequence	Measure with a multimeter to restore the correct phase sequence
E422	(0x) Driver board rated current input error		Spare alarm
E423	(0x) Driver board braking resistor overload		Refer to <a href="#">E089</a> Error Handling Method
E424	(0x) Driver board absolute encoder overheating		Refer to <a href="#">E090</a> Error Handling Method
E425	(0x) Driver board battery voltage is too low		Refer to <a href="#">E091</a> Error Handling Method
E426	(0x) Driver board multi turn position information lost	Battery type absolute encoder voltage is too low	Replacement battery
E427	(0x) Driver board driver and motor do not match	Driver and motor power do not match	Servo drive uses current limit; torque is limited to 50%
E428	(0x) Drive board origin return failed		Refer to <a href="#">E094</a> Error Handling Method
E429	(0x) The driver board main power is off	<ol style="list-style-type: none"> <li>1. The voltage is too low</li> <li>2. Power failure</li> </ol>	<ol style="list-style-type: none"> <li>1. Increase the voltage</li> <li>2. Maintenance power supply</li> </ol>
E430	(0x) Driver board offset angle failed		Spare alarm
E431	(0x) The driver board is powered off and restarted		Refer to <a href="#">E097</a> Error Handling Method
E432	(0x) Driver board initialization LAN9252 error		Spare alarm
E433	(0x) Communication between driver board DSP and ESC is interrupted		Spare alarm
E434	(0x) The communication between the driver board and the host is interrupted through a network cable		Spare alarm
E435	(0x) Driver board PDO communication parameters are read only		Spare alarm
E436	(0x) No index for driver board PDO communication		Spare alarm



Error Code	Error description	Fault Cause	Solution
E437	(0x) Driver board PDO communication synchronization time is out of range		Spare alarm
E438	(0x) Drive board initialization LAN9252 error		Spare alarm
E439	(0x) Driver board UVW short circuit		Refer to <a href="#">E105</a> Error Handling Method
E440	(0x) Drive board inertia identification failed		Spare alarm
E441	(0x) Drive board encoder EEPROM read and write failed		Spare alarm
E442	(0x) limit of driver board position		Spare alarm
E443	(0x) Negative limit of driver board position		Spare alarm
E444	(0x) Driver board electronic gear ratio range		Refer to <a href="#">E110</a> Error Handling Method
E445	(0x) Driver board input pulse frequency is too high		Refer to <a href="#">E132</a> Error Handling Method
E446	(0x) Driver board motor overheating warning		Refer to <a href="#">E081</a> Error Handling Method
E447	(0x) Drive board drive overheat warning		Refer to <a href="#">E081</a> Error Handling Method
E448	(0x) Driver board motor overload warning		Refer to <a href="#">E026</a> Error Handling Method
E449	(0x) Drive board drive overload warning		Refer to <a href="#">E026</a> Error Handling Method
E450	(0x) Driver board position deviation too large warning		Refer to <a href="#">E419</a> Error Handling Method
E451	(0x) Driver board brake overload warning		Refer to <a href="#">E026</a> Error Handling Method
E452	(0x) Drive board forward overtravel warning	Exceeds the software limit set value set by the system	Modify setting parameters or reset
E453	(0x) Drive board reverse overtravel warning	Exceeded the set target itinerary	Press the reset button to reset
E470	(0x) driver board overpressure	Regulator failure	Overhaul voltage regulator
E471	(0x) Driver board undervoltage	1. Insufficient voltage, the external input voltage is too low 2. Harmonic interference	1. Replace the power supply or add a regulator 2. It is necessary to install a special filter at the input end of the servo drive to solve the problem
E472	(0x) Driver board hardware overcurrent	1. The power supply voltage is too large 2. The hardware is damaged, resulting in too small resistance	1. Buck treatment 2. Replace the hardware
E473	(0x) Driver board software overcurrent		Refer to <a href="#">E023</a> Error Handling Method

Error Code	Error description	Fault Cause	Solution
E474	(0x) Driver board encoder failure		Refer to <a href="#">E024</a> Error Handling Method
E475	(0x) Driver board is open		Refer to <a href="#">E025</a> Error Handling Method
E476	(0x) Drive board overload		Refer to <a href="#">E026</a> Error Handling Method
E477	(0x) The driver board is out of position		Refer to <a href="#">E027</a> Error Handling Method
E478	(0x) Driver board AD sampling failure		Refer to <a href="#">E028</a> Error Handling Method
E479	(0x) Driver board overheated		Refer to <a href="#">E029</a> Error Handling Method



## 5. MAINTENANCE OF SAWING MACHINE

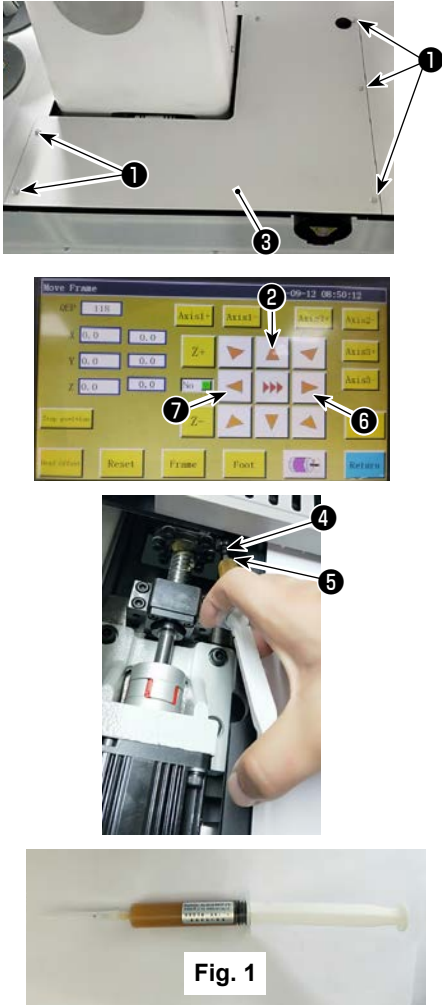

**WARNING :**

Turn OFF the power before starting the work so as to prevent accidents caused by abrupt start of the sewing machine. In addition, attach the covers which have been removed before operation back in place.

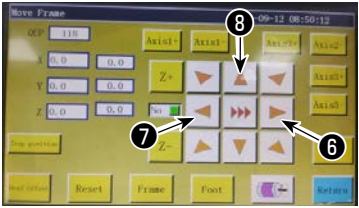
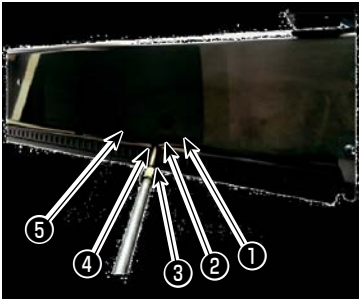
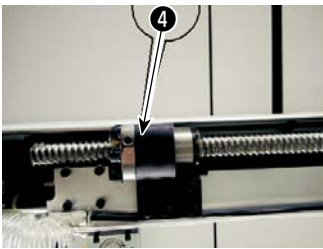
No.	Region	Explanation	Operating time
1	<p>The area under the throat plate, area surrounding the hook, bobbin case and its inner portion, thread trimming area, needle bar area, areas inside and outside of the presser foot, openings of the electronic control box such as air inlet and outlet, and the regions in which thread waste, thread end and other stains are likely to remain.</p> 	<p>Clean up the surface of equipment with a tool such as an air gun. In particular, clean up the regions in which the aforementioned thread waste, thread end and other stains are likely to remain.</p>	Eight hours
2	<p>Lubricate the machine through the Y-direction ball screw nut oil hole.</p> 	<ol style="list-style-type: none"> <li>1. Remove screw ❶ . Detach mid-plate back cover ❸ .</li> <li>2. Enter the manual frame travel screen from the operation panel. Press key ❷ to move the X-direction linear module backward. In addition, move oil hole ❹ on the Y-direction ball screw nut to the lower side of the middle plate rear cover.</li> <li>3. Aligning tip ❺ of grease-filled syringe (in Fig. 1) with oil hole ❹ , add oil through the oil hole.</li> <li>4. Lubricate each portions requiring lubrication at least five times. The oil amount for each portion should not fall below 5cm<sup>3</sup>.</li> <li>5. Every time the grease is added through oil hole, press key ❻ and ❷ several times to move the Y ball screw nut back and forth to spread the lubricating oil over the clearance between balls.</li> <li>6. After the completion of lubrication, check to make sure that the grease exudes between the ball screw and the nut.</li> <li>7. After the completion of lubrication, move the rear cover of the middle plate to its home position, and tighten screw ❶ .</li> <li>8. Lithium based grease No. 2 should be used as lubricating grease. Do not use it with mixed with other type of lubricating grease.</li> </ol>	<p>According to the usage environment, the sewing machine may sew 100 million stitches. (Lubrication should be carried out when one of the following conditions has been reached.) When the sewn number of stitches has reached 100 million stitches; or When the sewing machine has been used for three months</p>

No.	Region	Explanation	Operating time
3	<p data-bbox="240 163 679 226">Lubricate the machine through X-direction ball screw nut oil hole.</p>    	<ol style="list-style-type: none"> <li data-bbox="695 163 1121 226">1. Detach rubber plug ❶ .</li> <li data-bbox="695 237 1121 461">2. Enter the frame travel screen from the operation panel. Press key ❷ to move the pattern presser device on the X-direction linear module to the left. In addition, move oil hole ❹ on the X-direction ball screw nut to the underside of hole ❷ in cover ❸ .</li> <li data-bbox="695 472 1121 573">3. Aligning syringe tip ❸ with filler port ❹ , squeeze the syringe to add oil through the oil hole.</li> <li data-bbox="695 584 1121 707">4. Lubricate each portions requiring lubrication at least five times. The oil amount for each portion should not fall below 5cm<sup>3</sup>.</li> <li data-bbox="695 719 1121 943">5. Every time the grease is applied through oil hole, press key ❹ and ❺ several times to move the X ball screw nut to the right and left to spread the lubricating oil over the clearance between balls.</li> <li data-bbox="695 954 1121 1077">6. After the completion of lubrication, check to make sure that the grease exudes between the ball screw and the nut.</li> <li data-bbox="695 1088 1121 1189">7. After the completion of lubrication, return rubber plug ❶ to its original position.</li> <li data-bbox="695 1200 1121 1357">8. Lithium based grease No. 2 should be used as lubricating grease. Do not use it with mixed with other type of lubricating grease.</li> </ol>	<p data-bbox="1137 163 1430 293">According to the usage environment, the sewing machine may sew 100 million stitches.</p> <p data-bbox="1137 304 1430 434">(Lubrication should be carried out when one of the following conditions has been reached.)</p> <p data-bbox="1137 445 1430 640">When the sewn number of stitches has reached 100 million stitches; or When the sewing machine has been used for three months</p>

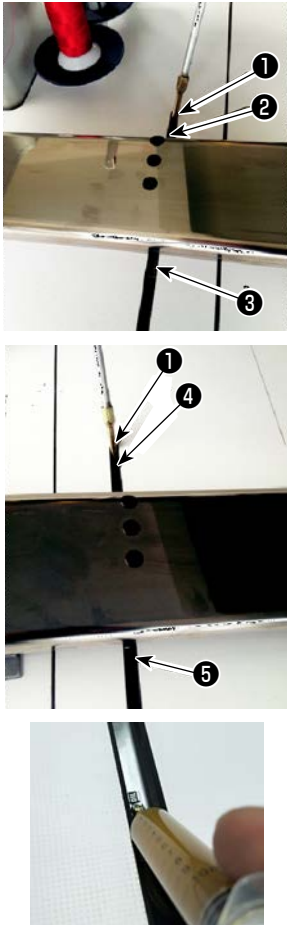
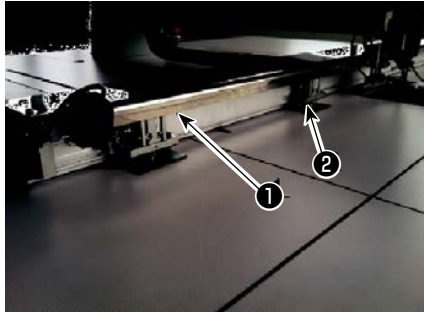
No.	Region	Explanation	Operating time
4	<p>Lubricate two Y-direction linear guide sliders through their four oil holes.</p> 	<ol style="list-style-type: none"> <li>1. Aligning needle tip ① with Y-direction linear guides ② , ③ , ④ and ⑤ , squeeze the syringe to add oil to the oil hole of the respective linear guides.</li> <li>2. Lubricate each portions requiring lubrication at least five times. The oil amount for each portion should not fall below 5cm<sup>3</sup>.</li> <li>3. Every time the grease is applied through the oil hole, press the slider on the linear guide several times to spread the grease over the clearance between balls.</li> <li>4. After a sufficient amount of grease is added, check to make sure that the grease exudes between the ball screw and the nut.</li> <li>5. Lithium based grease No. 2 should be used as lubricating grease. Do not use it with mixed with other type of lubricating grease.</li> </ol>	<ol style="list-style-type: none"> <li>1. Replenish the machine with lubricating grease again after the equipment has run 6400 km or for five years.</li> <li>2. According to the environment of usage, apply the lubricating grease once every three months or when the sewing machine has sewn 100 million stitches after the first lubrication.</li> </ol>
5	<p>Apply oil to two oil holes of the X-direction linear guide sliders.</p> 	<ol style="list-style-type: none"> <li>1. Aligning the tip of syringe with oil holes ① and ② , squeeze the syringe to respectively add oil through oil holes ① and ② until oil they are filled with oil once.</li> <li>2. Lubricate each portions requiring lubrication at least five times. The oil amount for each portion should not fall below 5cm<sup>3</sup>.</li> <li>3. Every time the grease is added through the oil hole, press the slider on the linear guide several times to spread the grease sufficiently over the clearance between balls.</li> <li>4. After a sufficient amount of grease is added, check to make sure that the grease exudes between the linear guide and the slider.</li> <li>5. Lithium based grease No. 2 should be used as lubricating grease. Do not use it with mixed with other type of lubricating grease.</li> </ol>	<ol style="list-style-type: none"> <li>1. Replenish the machine with lubricating grease again after the equipment has run 6400 km or for five years.</li> <li>2. According to the environment of usage, apply the lubricating grease once every three months or when the sewing machine has sewn 100 million stitches after the first lubrication.</li> </ol>

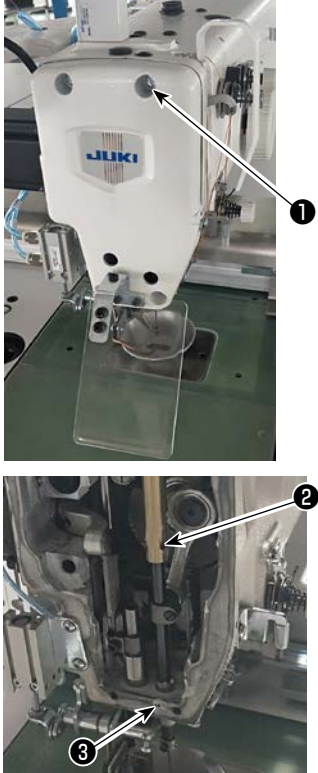
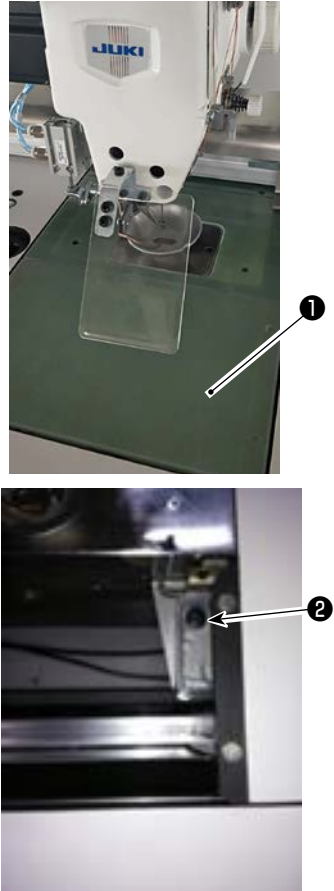
No.	Region	Explanation	Operating time
6	<p>Apply grease to the upper and lower covers of needle bar, needle bar slide groove, guide frame groove of the presser bar, presser bar, etc.</p> 	<ol style="list-style-type: none"> <li>1. Loosen screw ❶ of the face plate. Detach the face plate.</li> <li>2. Loosen and remove screw ❷ of the needle bar upper bushing and ❸ of the needle bar lower bushing.</li> <li>3. Align the grease gun oil hole with tapped holes ❷ and ❸ of the upper and lower bushings of the needle bar to lubricate.</li> <li>4. The oil amount to be added should not fall below 0.5cm<sup>3</sup>.</li> <li>5. After the completion of lubrication, tighten the screws of upper and lower bushings of the needle bar.</li> <li>6. At the same time, apply an appropriate amount of grease to the needle bar slide groove, needle bar guide frame groove, presser bar, etc.</li> <li>7. Lithium based grease No. 2 should be used as lubricating grease. Do not use it with mixed with other type of lubricating grease.</li> </ol>	<ol style="list-style-type: none"> <li>1. Replenish the machine with lubricating grease again after the equipment has run 6400 km or for five years.</li> <li>2. According to the environment of usage, apply the lubricating grease once every three months or when the sewing machine has sewn 100 million stitches after the first lubrication.</li> </ol>
7	<p>Lubricate the hook oil tank.</p> 	<ol style="list-style-type: none"> <li>1. Detach cover ❶ .</li> <li>2. Remove rubber plug ❷ of the oil tank.</li> <li>3. Pour accessory (or specified) oil to the oil tank through the rubber plug hole.</li> <li>4. When the oil amount in the oil tank reaches the upper scale mark, stop pouring oil.</li> <li>5. Return the rubber plug to and return the cover to their original positions.</li> </ol>	<p>If the oil level in the oil tank drops below the lower scale marker, replenish the oil tank with the accessory (or specified) oil.</p>

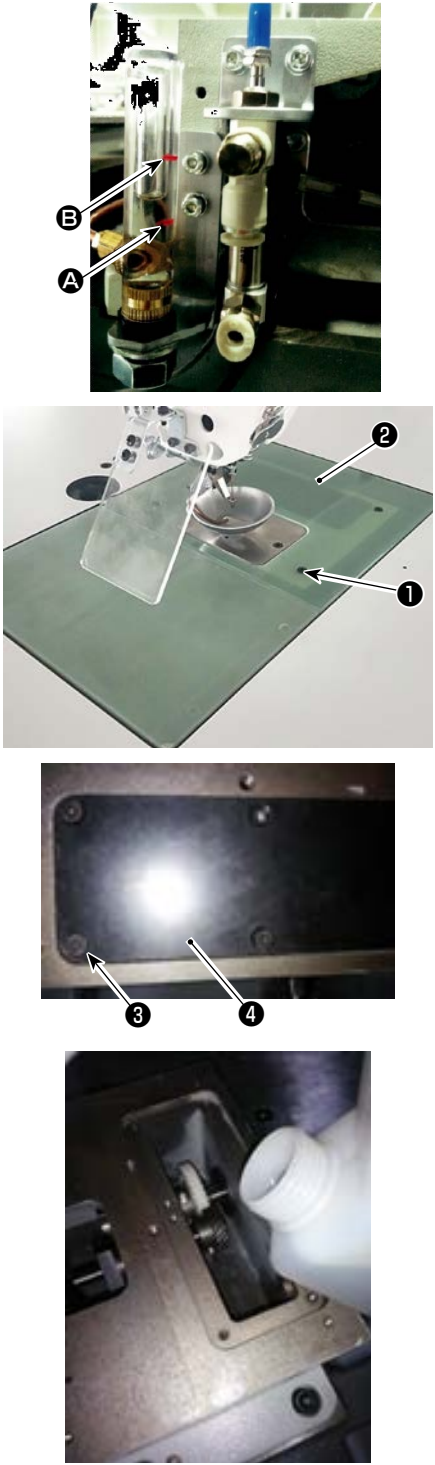
No.	Region	Explanation	Operating time
8	<p data-bbox="240 163 681 226">Adding the lubricating oil to the gear box.</p> 	<ol style="list-style-type: none"> <li data-bbox="697 163 1121 297">1. Remove four screws <b>1</b> . Detach hook cover <b>2</b> . Remove six screw <b>3</b> . Detach gear box cover <b>4</b> and gasket.</li> <li data-bbox="697 297 1121 360">2. Pour No. 32 white oil to the gear box little by little.</li> <li data-bbox="697 360 1121 468">3. When the oil amount reaches the upper scale mark <b>B</b> of the oil level gauge, stop pouring oil.</li> <li data-bbox="697 468 1121 607">4. Return the cover and gasket of the gear box, and hook cover to their original positions. Tighten the screw.</li> </ol>	<p data-bbox="1137 163 1441 360">Replenish the gear box with No. 32 white oil if the oil surface shown on the level gauge falls below the lower scale mark <b>A</b> .</p>

## 5-1. Troubles and corrective measures (Sewing conditions)

Trouble	Cause	Corrective measures
1. The needle thread slips off at the start of bar-tacking.	<ul style="list-style-type: none"> <li>① Stitches are slipped at the start.</li> <li>② The needle thread remaining on the needle after thread trimming is too short.</li> <li>③ The bobbin thread is too short.</li> <li>④ Needle thread tension at 1st stitch is too high.</li> <li>⑤ Stitching pitch at 1st stitch is too small.</li> </ul>	<ul style="list-style-type: none"> <li>○ Adjust the clearance provided between the needle and the hook.</li> <li>○ Set soft-start sewing at the beginning of sewing.</li> <li>○ Decrease the tension of the thread tension controller No. 1.</li> <li>○ Increase the tension of the thread take-up spring.</li> <li>○ Decrease the bobbin thread tension.</li> <li>○ Increase the clearance between the needle and the counter knife.</li> <li>○ Decrease the needle thread tension at 1st stitch, and extend the duration of the AT operation at the beginning of sewing.</li> <li>○ Make the stitching pitch at 1st stitch longer.</li> <li>○ Decrease the needle thread tension at 1st stitch.</li> </ul>
2. Thread often breaks or synthetic fiber thread splits finely.	<ul style="list-style-type: none"> <li>① The hook or the inner hook holder has scratches.</li> <li>② The needle hole guide has scratches.</li> <li>③ Thread enters the groove in the hook.</li> <li>④ The needle thread tension is too high.</li> <li>⑤ The tension of the thread take-up spring is too high.</li> <li>⑥ The synthetic fiber thread melts due to heat generated on the needle.</li> <li>⑦ When taking up the thread, the needle tip penetrates the thread.</li> </ul>	<ul style="list-style-type: none"> <li>○ Remove the hook and grind hook or the inner hook holder with a fine grind stone or buff them.</li> <li>○ Buff the needle hole guide or replace it with a new one.</li> <li>○ Detach the hook to remove the thread.</li> <li>○ Decrease the needle thread tension.</li> <li>○ Decrease the tension of the thread take-up spring.</li> <li>○ Use the optional needle cooler.</li> <li>○ Check the rough state of needle tip.</li> <li>○ Use the ball-pointed needle.</li> </ul>
3. The needle often breaks.	<ul style="list-style-type: none"> <li>① The needle is bent.</li> <li>② The needle comes in contact with the intermediate presser.</li> <li>③ The needle is too thin for the material.</li> <li>④ Clearance between the needle and the hook is too small.</li> </ul>	<ul style="list-style-type: none"> <li>○ Replace the bent needle.</li> <li>○ Adjust the position of the intermediate presser.</li> <li>○ Replace it with a thicker needle according to the material.</li> <li>○ Adjust the clearance between the needle and the hook.</li> </ul>
4. Threads are not trimmed.  (Bobbin thread only)	<ul style="list-style-type: none"> <li>① The counter knife is dull.</li> <li>② Knife pressure of the counter knife is low.</li> <li>③ The counter knife has been improperly positioned.</li> <li>④ The last stitch is skipped.</li> <li>⑤ Bobbin thread tension is too low.</li> <li>⑥ Flopping of cloth</li> </ul>	<ul style="list-style-type: none"> <li>○ Replace the counter knife.</li> <li>○ Adjust the knife pressure of the counter knife.</li> <li>○ Correct the position of the counter knife.</li> <li>○ Correct the timing between the needle and the hook.</li> <li>○ Increase the bobbin thread tension.</li> <li>○ Lower the intermediate presser height.</li> </ul>
5. Stitch skipping often occurs.	<ul style="list-style-type: none"> <li>① Clearance provided between the needle and the hook is not correct.</li> <li>② Position of the inner hook holder against the needle is not correct.</li> <li>③ The needle is bent.</li> <li>④ The needle thread after thread trimming is too long.</li> </ul>	<ul style="list-style-type: none"> <li>○ Adjust the clearance between the needle and the hook.</li> <li>○ Adjust the position of the inner hook holder against the needle.</li> <li>○ Replace the bent needle.</li> <li>○ Decrease the tension of the thread take-up spring.</li> <li>○ Increase the tension of the thread tension controller No. 1.</li> </ul>
6. The needle thread comes out on the wrong side of the material.	<ul style="list-style-type: none"> <li>① The needle thread tension is not high enough.</li> <li>② The needle thread after thread trimming is too long.</li> </ul>	<ul style="list-style-type: none"> <li>○ Increase the needle thread tension.</li> <li>○ Increase the tension of the thread tension controller No. 1.</li> </ul>
7. Threads break at time of thread trimming.	<ul style="list-style-type: none"> <li>① The knife has been improperly position.</li> </ul>	<ul style="list-style-type: none"> <li>○ Correct the position of the knife.</li> </ul>



Trouble	Cause	Corrective measures
8. Thread end of the 1st stitch comes out on the right side of the material.	<ul style="list-style-type: none"> <li>① Stitch skipping at the 1st stitch.</li> <li>② Needle used and thread used are thick in terms of the inner diameter of the intermediate presser.</li> <li>③ Intermediate presser is not properly positioned in terms of the needle.</li> <li>④ The direction of air blower is incorrect. As a result, needle thread at the tip of needle cannot be clamped with the disc presser.</li> </ul>	<ul style="list-style-type: none"> <li>○ Increase the length of needle thread remaining at the needle after thread trimming.</li> <li>○ Change the current intermediate presser with another one which has a larger inner diameter.</li> <li>○ Adjust the eccentricity between intermediate presser and needle so that needle enters in the center of intermediate presser.</li> <li>○ Adjust the air-blowing direction of the air blower according to the direction of sewing so that the needle thread at the tip of needle can be clamped with the disc presser.</li> </ul>
9. The needle thread is entangled in the inner hook holder.	<ul style="list-style-type: none"> <li>① The clearance provided between the inner hook holder and the inner hook is too small.</li> </ul>	<ul style="list-style-type: none"> <li>○ Adjust the clearance provided between the inner hook holder and the inner hook appropriately according to the thickness of needle thread to be used.</li> </ul>
10. The knotting section of bobbin thread at 2nd stitch at the sewing start appears on the right side.	<ul style="list-style-type: none"> <li>① The bobbin runs idle excessively.</li> <li>② Bobbin thread tension is too low.</li> <li>③ The needle thread tension at 1st stitch is too high.</li> </ul>	<ul style="list-style-type: none"> <li>○ Adjust the height of idling prevention spring of the bobbin case appropriately.</li> <li>○ Increase the bobbin thread tension.</li> <li>○ Decrease the needle thread tension at 1st stitch.</li> </ul>

## 5-2. Disposal of batteries



The operation panel has a built-in battery in order to operate the clock even when the power is turned OFF. Be sure to dispose of the battery following the local laws and regulations.

### ■ How to remove the battery



1) Release lock ① of the door at the back or side face of the sewing machine to open the door.

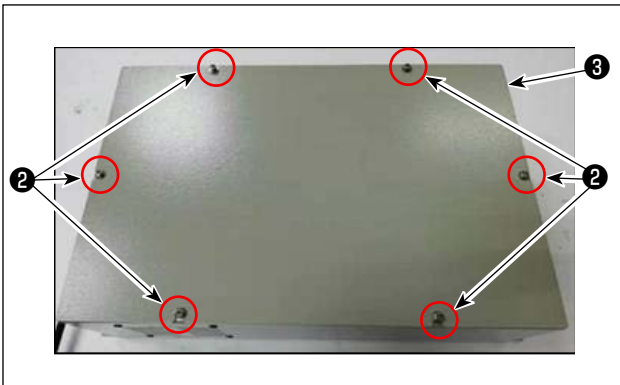

2) Remove cover setscrews ② of electrical box ③ that is located inside the door. Then, detach the front cover of the electrical box.

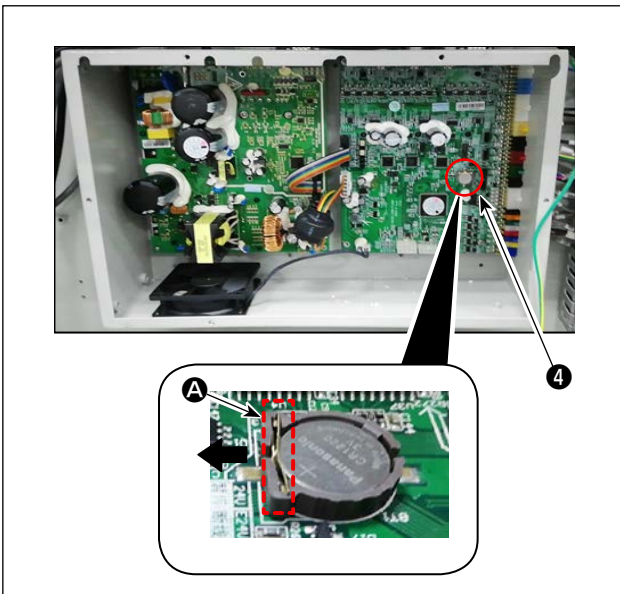

3) Slide stopper ① of battery ④ in the direction of the arrow to detach battery ④ .

## 6. SUBCLASS MODEL

### 6-1. Barcode reader



#### WARNING :

Be sure to turn OFF the power supply and air supply to the sewing machine before attaching the parts in order to protect against accidents caused by an unintended start of the sewing machine.

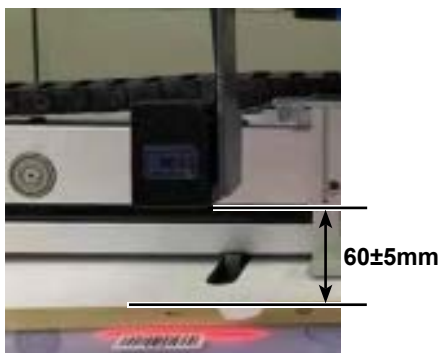
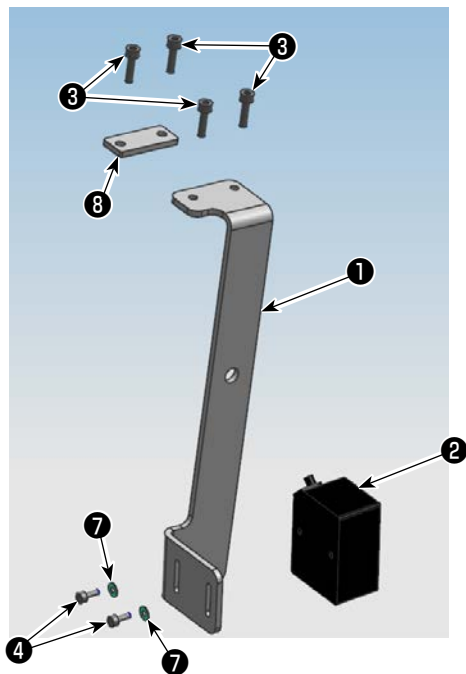

#### 1. Installing the parts

- 1) Secure barcode reader ② and mounting plate ① with screw ④ .

No.	Part number	Part name	Quantity
①	40234788	Barcode reader mounting plate	1
②	40235199	Barcode reader	1
③	40234468	Screw	4
④	40235200	Screw	2
⑤	40235332	Cable clip band	1
⑥	40235331	Barcode	1
⑦	40234514	Washer	2
⑧	40240831	Mounting plate	1

- 2) Detach screws ⑨ (four pieces) of the operation panel mounting base. Install mounting plate ① under the operation panel mounting base with screws ③ (two pieces).  
Install mounting plate ⑧ under the operation panel mounting base with screws ③ (two pieces).

- 3) Adjust the position of barcode reader ② so that it is spaced  $60\pm 5$  mm. Then, secure it with screw ④ . Connect the plug of barcode reader to the panel. Pass cable clip band ⑤ through the hole in mounting plate ① and bundle the barcode reader cable with the cable clip band.



**When bundling the barcode cable, slightly loosen the cable near the barcode reader.**

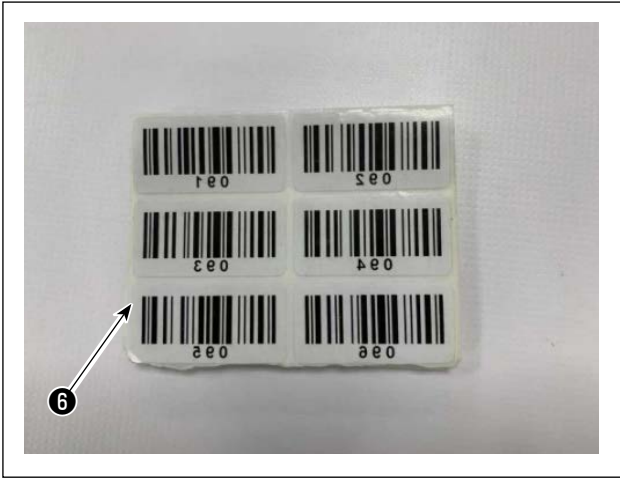

4) Take out a seal from barcode seals ⑥ provided.

 One hundred barcode seals (with serial numbers from 001 to 100) are provided.

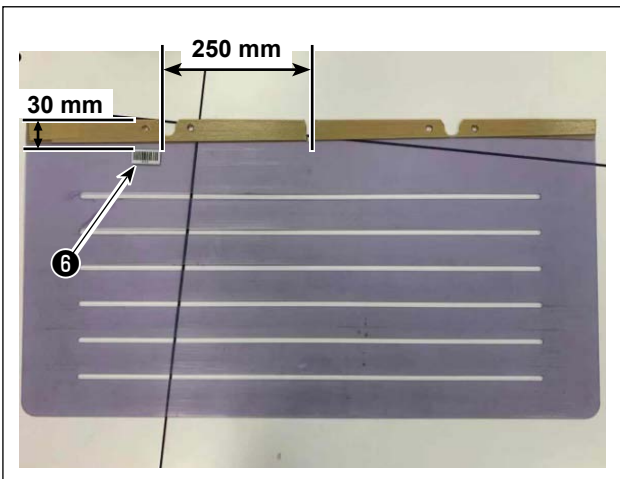

5) Stick the barcode seal to the cassette at the position that is 250 mm left from the center of cassette (setup guide) and 30 mm below the upper side of cassette.

 The aforementioned sticking position is recommended. It is acceptable to stick the barcode seal at any position that will not interfere with the recognition of the barcode seal by the barcode reader.

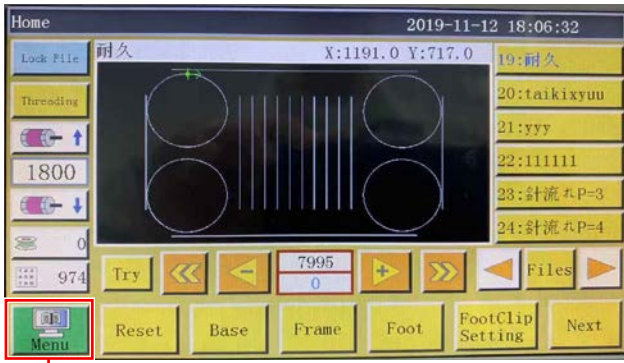

A

## 2. Setting the barcode functions

### ● Setting the barcode functions on the operation panel

1) Press button **A**.

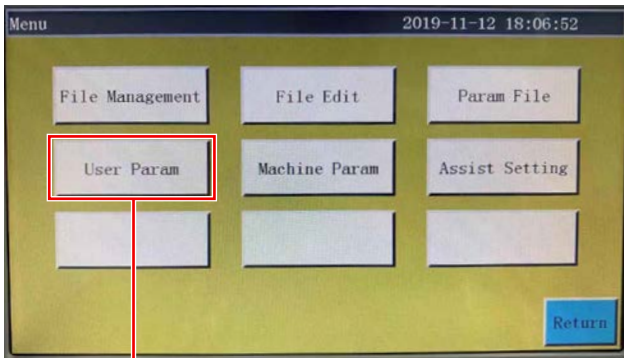

B

2) Press button **B**.

In the default state, the factory-set password is provided. The password is "11111111".

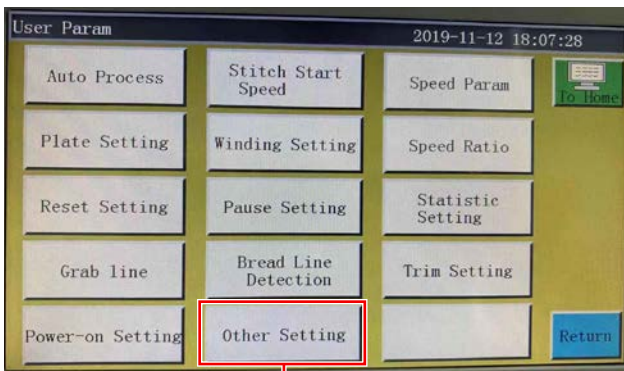

C

3) Press button **C**.

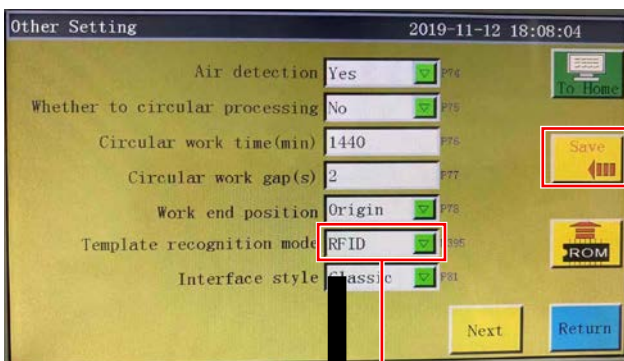

D

4) To allow the barcode reader to recognize the template, change **D** from "Electronic identification label" to "Barcode".

Then, press **E**.

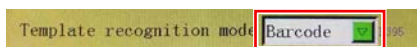

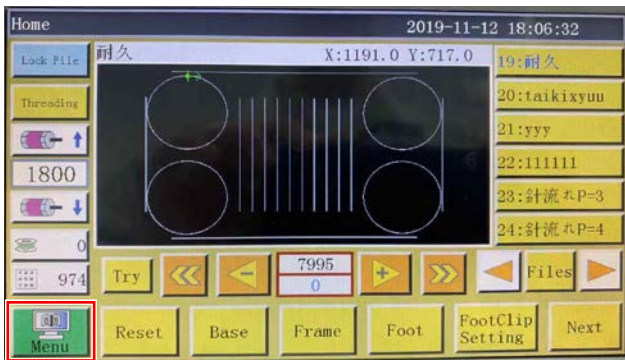

### ● Setting the barcode number

1) Press button **A**.

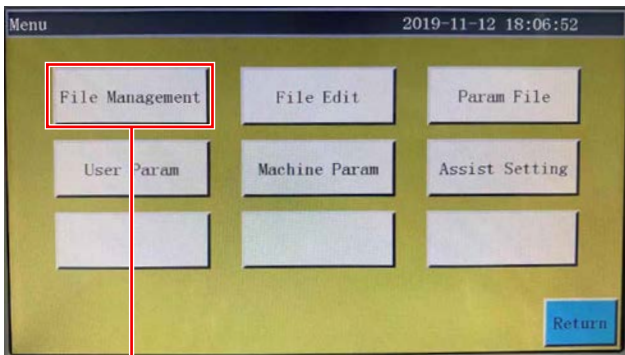

2) Press button **B**.



3) Select the sewing pattern file you want to read and press button **C**.

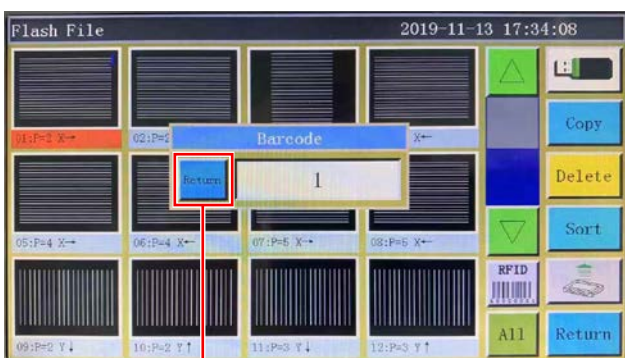

4) Press button **D**.  
Save the data.

## ● Cancelling the barcode number

When you want to cancel the barcode reader number, it is necessary to set the current number to the largest value (the largest one of unassigned numbers, such as 100) first. Then, change that number to "0".

Example)

1	2	3	4	5	6
		↓			
		0			

---

1	2	3	4	5	6
		↓			
		7 (or 8 to 100)			

When the number "3" is changed to "0", the subsequent numbers registered "4, 5 and 6" will also be erased.

To prevent the aforementioned erasure of registered numbers you do not want to erase, firstly set the barcode number to the largest available value "7", then change it to "0".

## ● How to use the barcode reader

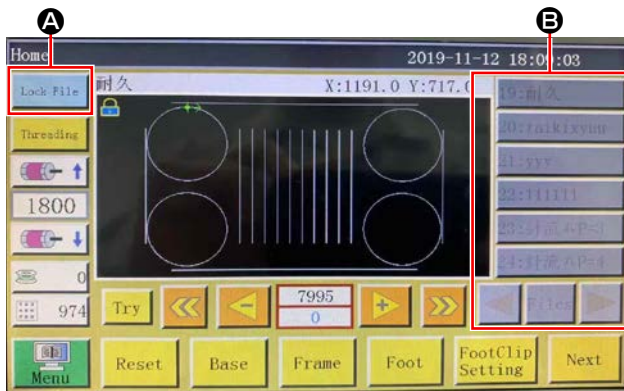

1) Press button **A** to lock the pattern conversion.

**Caution**  
The barcode is enabled by locking the pattern conversion. When the pattern conversion is locked, pattern list **B** changes its color to gray.



2) Place the barcode seal in the cassette right under the barcode reader.

When the barcode reader recognizes the barcode, the barcode reader beeps.

**Caution**  
If the barcode reader does not beep, adjust the vertical position of the barcode reader. If the pattern is not converted even when the barcode reader beeps, check the self lock.

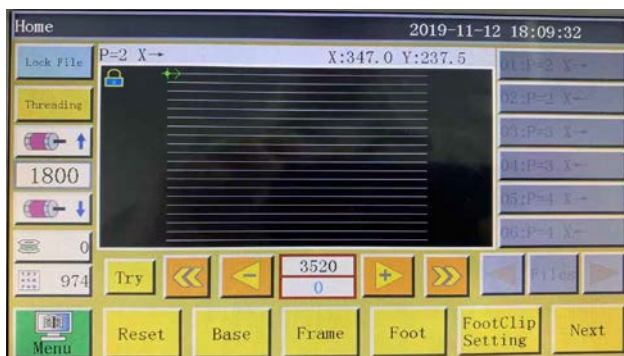

3) Check whether the pattern is converted appropriately.

## 6-2. Rotary knife

### 6-2-1. Safety precautions

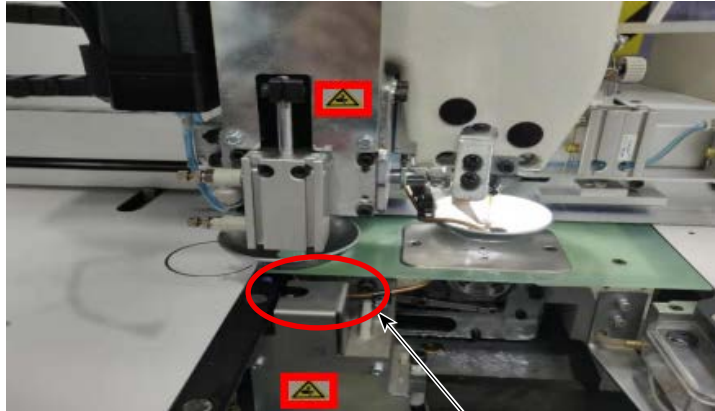

Putting a hand here is prohibited in order to protect against cuts and laceration.



1. Anyone other than the workers (persons concerned) is prohibited from touching the machine during installation and adjustment procedures.
2. Keep your hands away from the moving parts in order to protect against cuts while the knife is in operation.
3. Direct contact with the blade point of the counter knife and moving knife is prohibited in order to protect against scrapes and scratches.



## 6-2-2. How to carry out coaxial adjustment

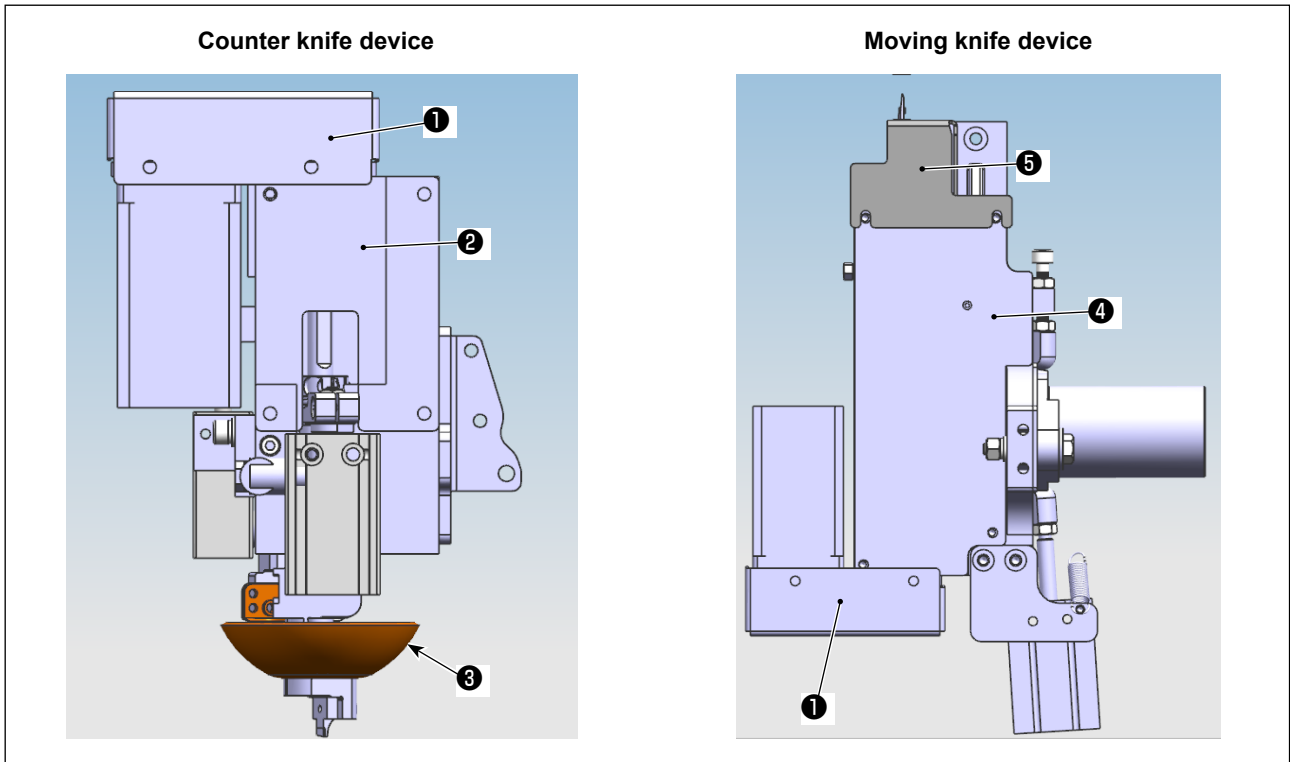

- 1) Turn OFF the power and air.
- 2) Detach upper fixing plate ② , lower fixing plate ④ , timing belt cover ① , moving knife cover ⑤ and knife clamp ③ .

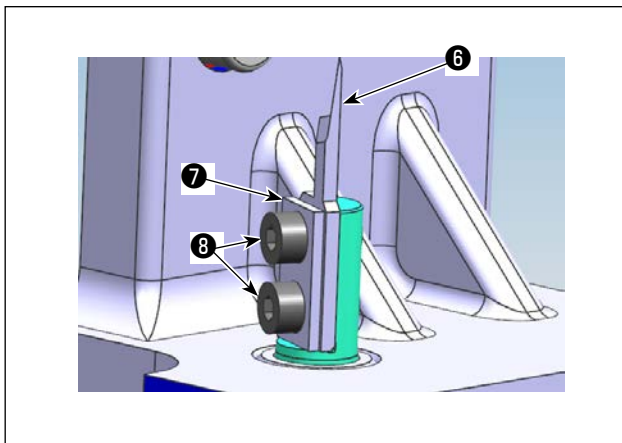

- 3) Detach the moving knife components (clamp plate ⑦ (one piece), one moving knife ⑥ (one piece) and setscrews ⑧ (two pieces)).

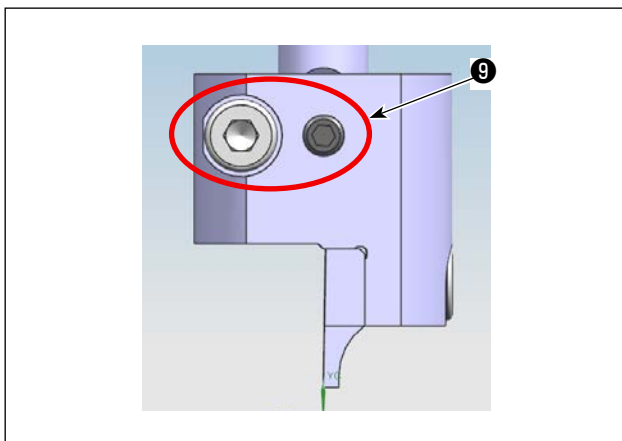

- 4) Loosen setscrews ⑨ (two pieces). Detach the counter knife asm.

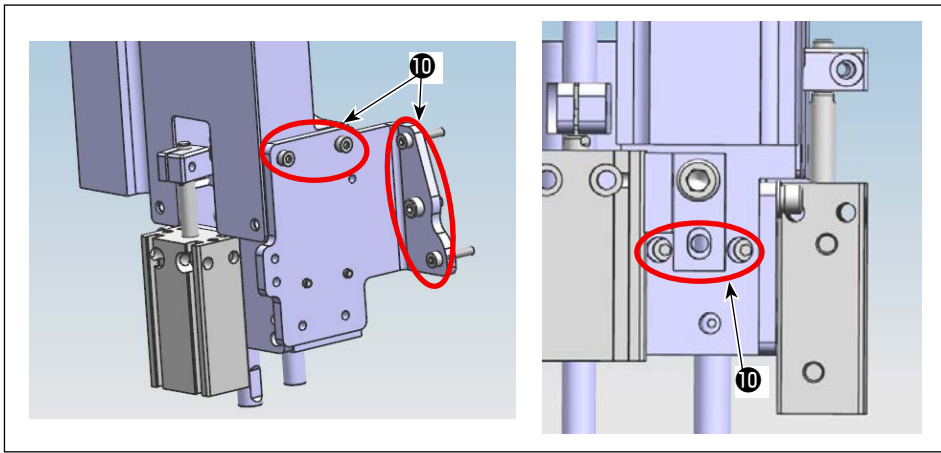

5) Loosen setscrews **10** (seven pieces) of the counter knife unit.

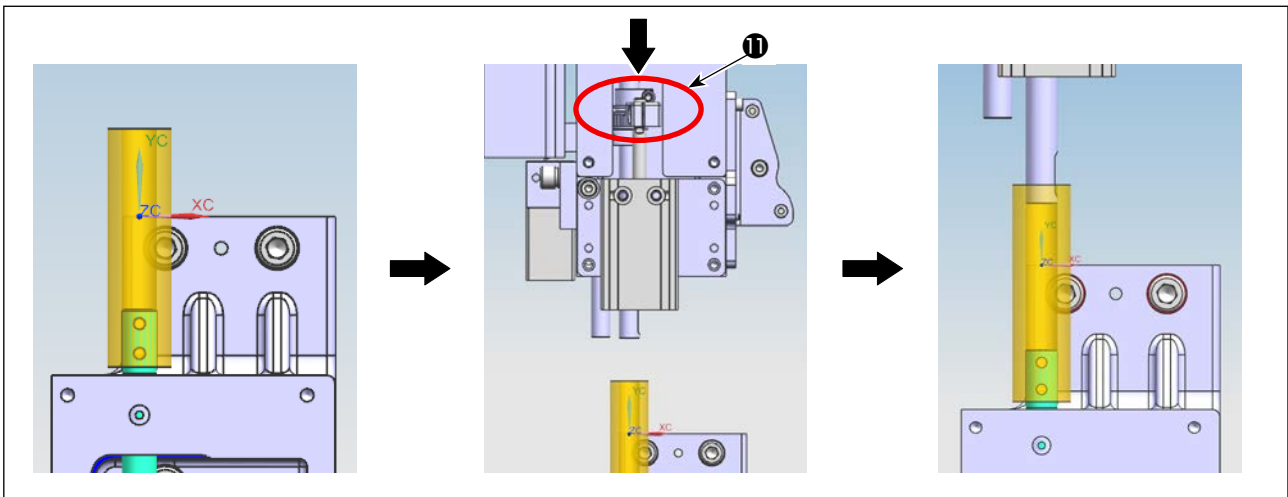

6) Fit the bushing jig into the moving knife shaft. Push down link **11** of the counter knife unit to put the counter knife shaft into the bushing jig.

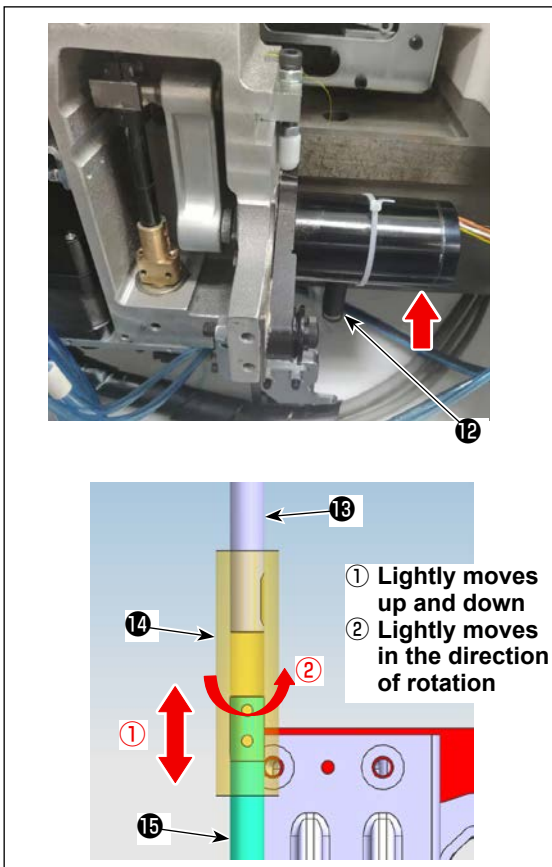

7) Remove reposition spring **12** of the moving knife. Lift up the drive motor.

8) Lifting bushing jig **14** while taking care to prevent it from interfering with the flat portion of moving knife shaft **15** / counter knife shaft **13**, adjust the position of the counter knife unit so that the bushing shaft lightly moves up and down and also lightly moves in the direction of rotation. Temporarily tighten the setscrew No. 4 of the counter knife unit.

9) Put reposition spring **12** on the spring hook. Turn ON the power and air to the sewing machine. Reset the origin.

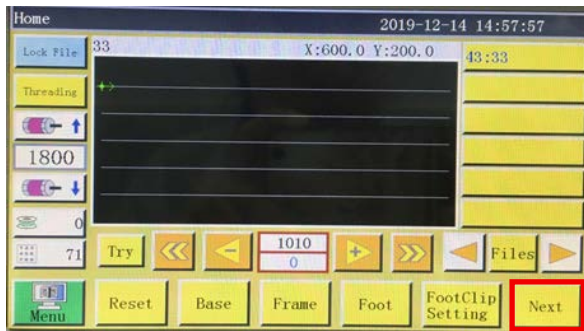

- 10) After resetting, proceed to the next page of the operation panel. ⇒  
 Press the "OUT1 (for single-substrate type machine head) / OUT 9 (for double-substrate type machine head)" to bring the tip of the counter knife shaft and that of the moving knife shaft closer to each other while fitting the bushing jig in position.

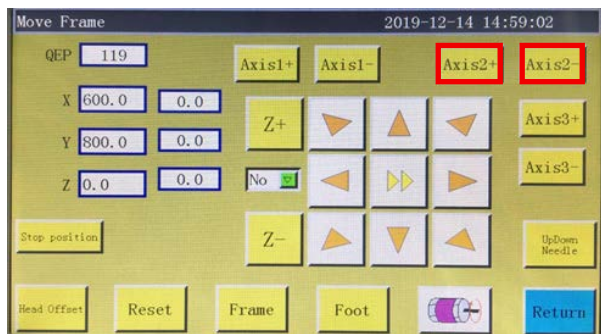
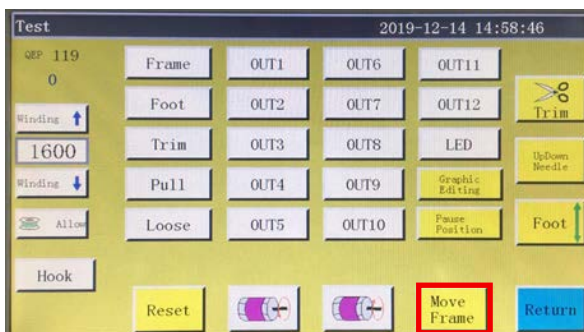

- 11) Press the manual feed. ⇒ , press the "shaft 2+ / shaft 2 -" button to turn the rotary knife for lifting the bushing jig as No. 6. Now, check that the bushing jig freely drops in each of the four directions (0 °, 90 °, 180 °, 270 °) and that it rotates smoothly.  
 If any malfunction occurs, adjust the position of the counter knife unit.

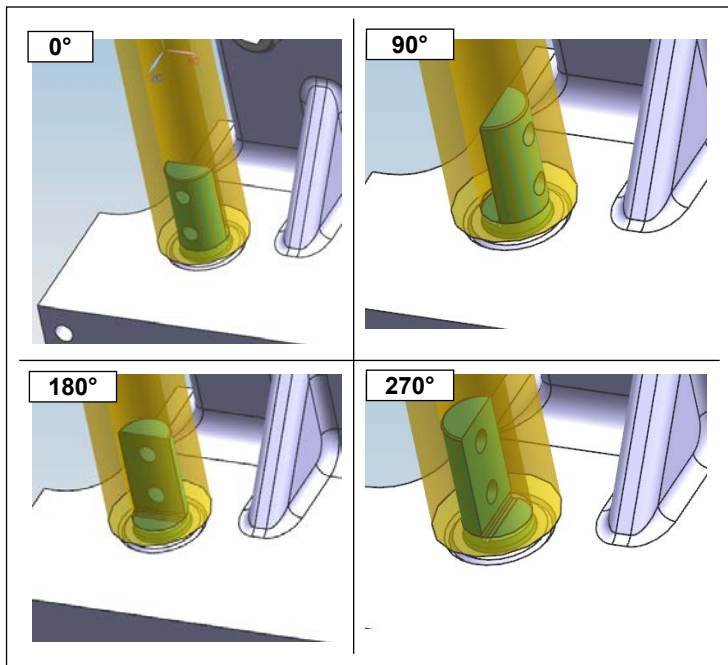

- 12) Check the operation status of the bushing jig respectively in the aforementioned four directions. Then, securely tighten the setscrew No. 4.  
 The position of the bushing jig may slightly shift from the adjusted position by securely tightening the setscrew No. 4. It is therefore necessary to check that the bushing jig smoothly rotates in the aforementioned four directions respectively.



Longer service life of the moving knife and counter knife is ensured provided that the maintenance workers from the manufacturer or the maintenance workers who have been trained with the related technology adjust the knife pressure optimally.

### 6-2-3 How to adjust the timing belt tension

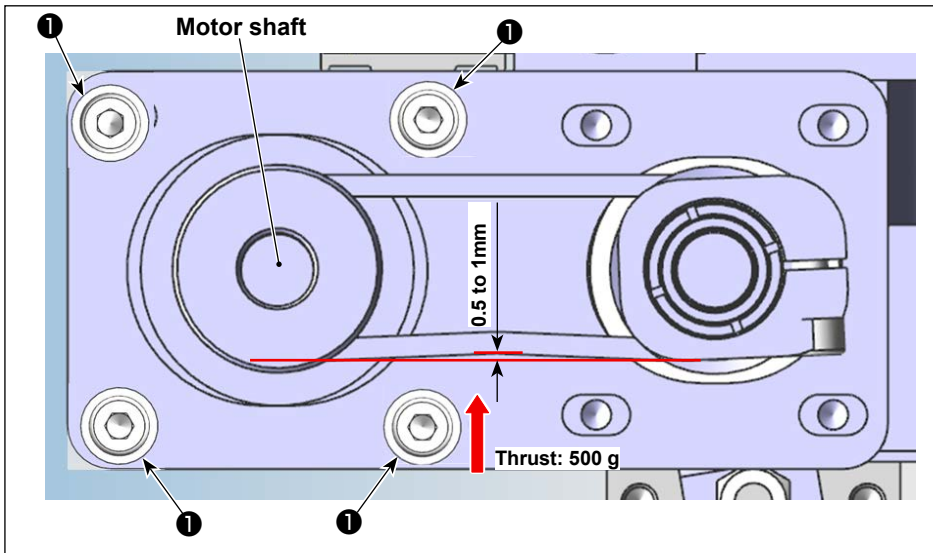

Measure the belt tension with a thrust meter and a pair of vernier calipers. If the belt tension falls out of the specification, loosen motor fixation screws ① (four pieces) and adjust the position of the motor appropriately.

### 6-2-4 How to adjust the knife pressure

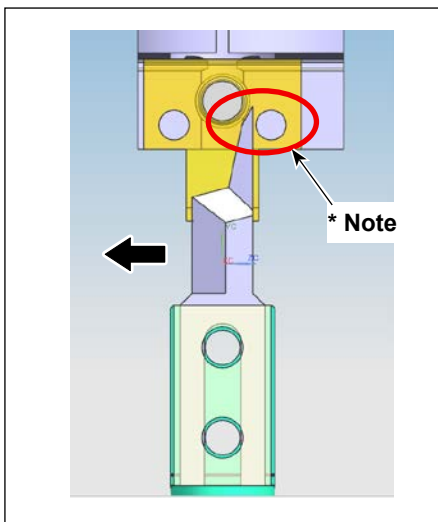

#### 6-2-4-1. Adjusting the mounting position of the moving knife

Install the moving knife vertically while shifting it toward the blade portion (in the direction of the arrow) so as to prevent the blade portion of the moving knife from coming in contact with the knife pressure adjustment screw of the counter knife.

\*Note: Do not allow the moving knife to interfere with the screw.

#### 6-2-4-2. Adjusting the direction of installation of the moving knife

Turn ON the power and air to the sewing machine. Reset the origin.

Shift setscrew ③ of the moving knife toward the far side of the sewing machine. Check to make sure that the moving knife is in parallel to the end face of the unit by observing the scale marks of scale ② .

If the moving knife is not in parallel with the end face of the unit, adjust the parallelism between them by loosening clamp screws ① .

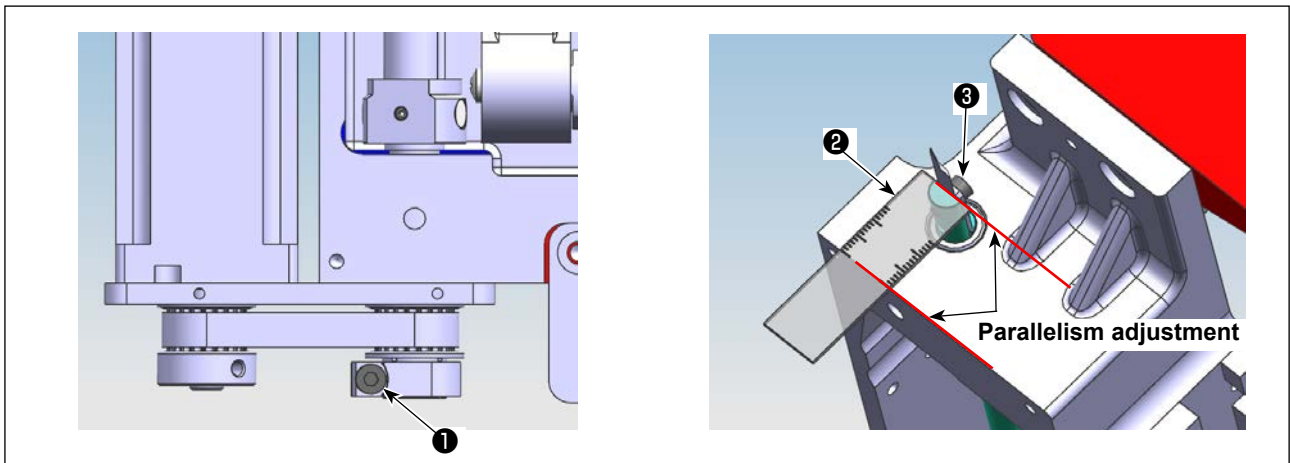

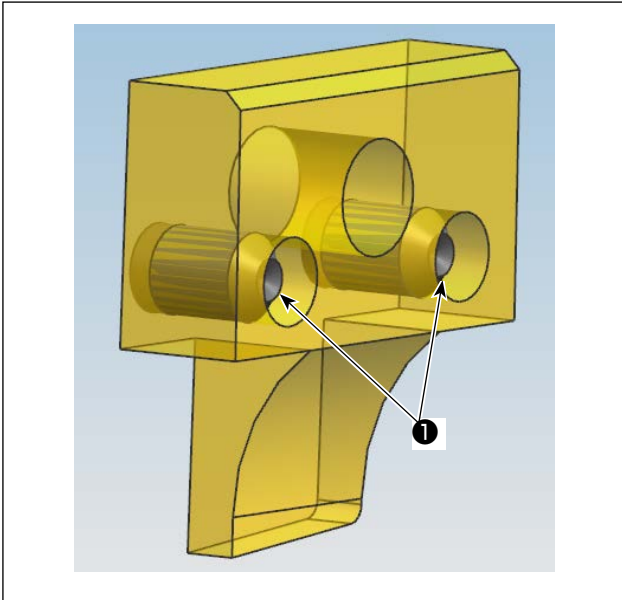

#### 6-2-4-3. Position of the knife pressure adjustment screw of the counter knife

Adjust the position of the knife pressure adjustment screw so that it does not protrude the end face of the counter knife.

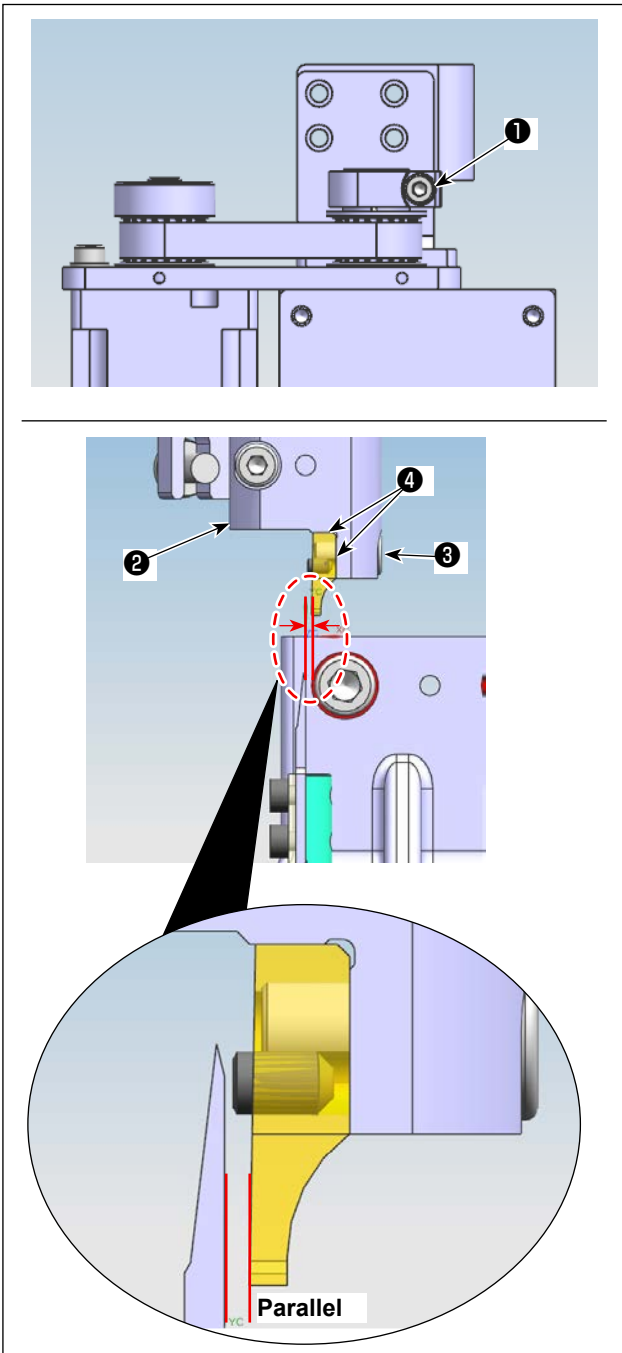

#### 6-2-4-4. Position of the knife pressure adjustment screw of the counter knife

Temporarily tighten setscrew **3** to allow the counter knife to be pressed against two portions **4** of mounting base **2**.

Loosen connection screw **1**. Turn the counter knife shaft by hand to adjust so that the counter knife is almost in parallel with the moving knife.

**Important**  
 Under the operation panel manual mode, press the "OUT1 (before the port change) / OUT9 (after the port change)" button to place it in the ON state. Bring the moving knife closer to the counter knife. Adjust the parallelism between them.

### 6-2-4-5. Adjustment of the height of the counter knife and moving knife

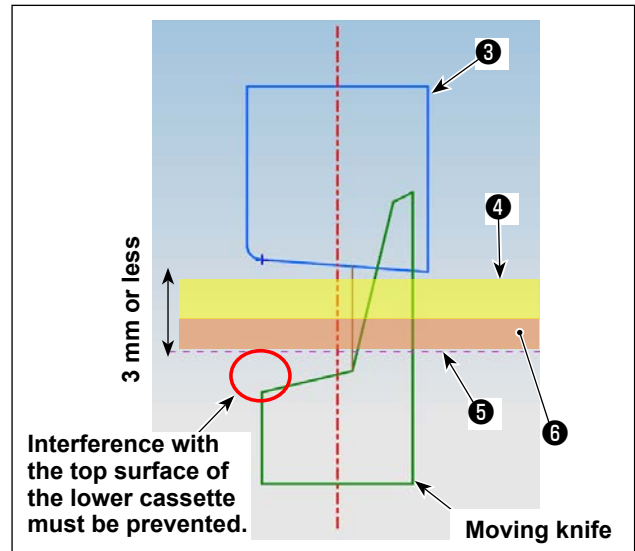
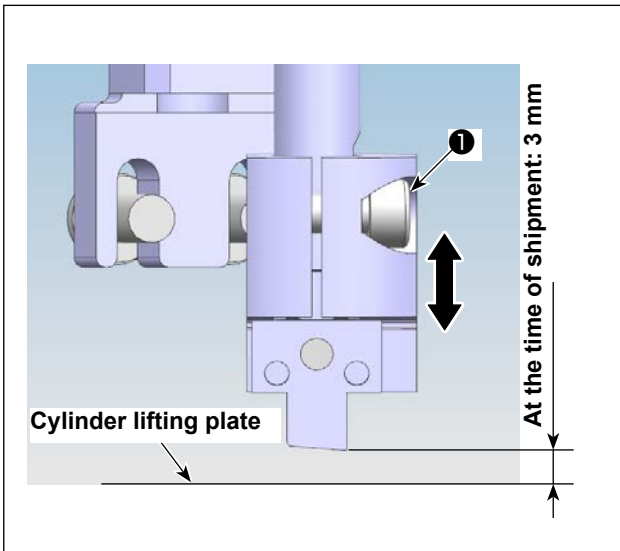

- 1) Loosen setscrews ① and ② of the counter knife base. Adjust the height of the counter knife.
- 2) In the normally shipped state, the sewing machine has been factory-adjusted so that the height of the blade point (lower end point) of the counter knife is 3 mm above the top surface of lifting plate ⑤ .  
If the total thickness of material ④ and lower cassette ⑥ is 3 mm or less, adjustment of the height of counter knife ③ will not be necessary.  
If this total thickness exceeds 3 mm, it will be necessary to adjust the height of counter knife ③ . (Up to 5.5 mm)

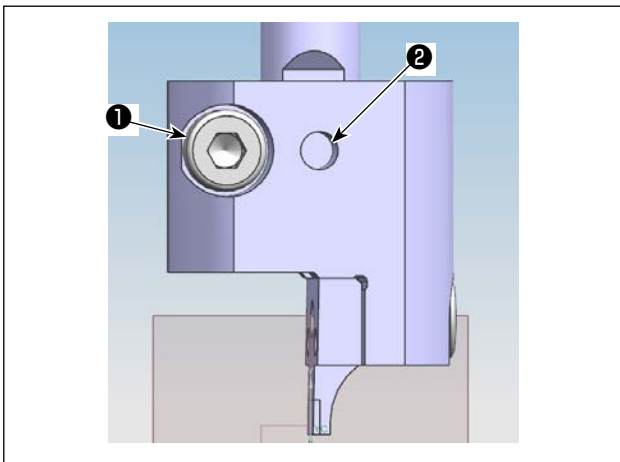

- 3) After you have adjusted the counter knife to an appropriate height, tighten first setscrew ② so that it is flush with the flat part of the counter knife shaft. Then, tighten setscrew ① .  
(Fix setscrew ② on the flat part of the counter knife shaft.)

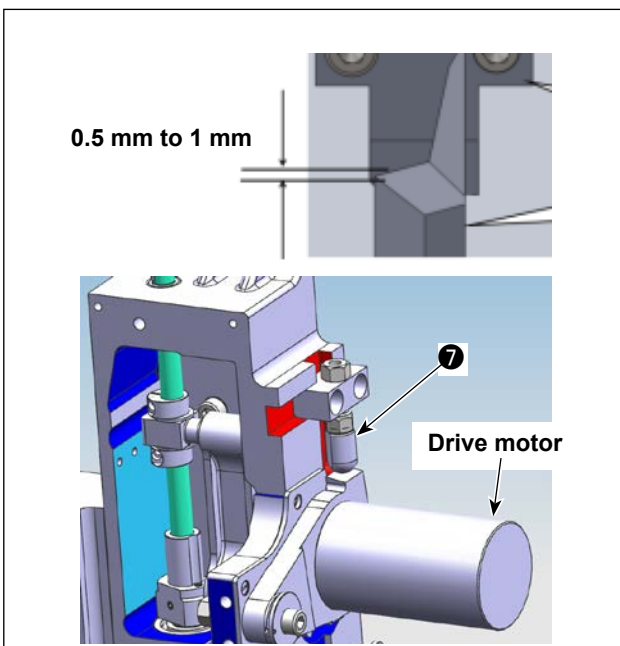

- 4) After you have adjusted the height of the counter knife, adjust the height of drive motor lifting stopper ⑦ so that the engagement amount between the moving knife and the counter knife is 0.5 to 1 mm.

**Lifting the drive motor by hand, check to make sure that the square portion of the moving knife blade does not interfere with the top surface of the lower cassette when the moving knife is at its lower dead point.**

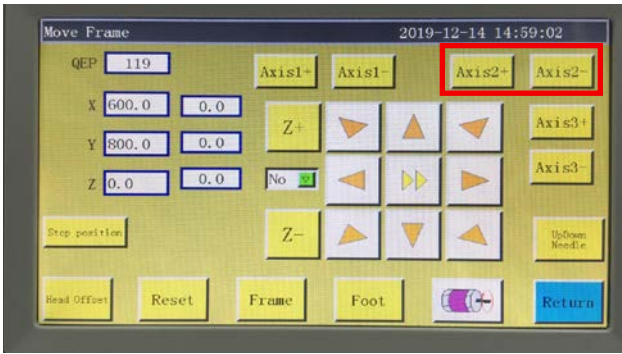

### 6-2-4-6. Adjusting the knife pressure

Under the manual mode, press the axis 2 button.

Turn the knife to change its direction so as to allow easy adjustment.

Push a hexagonal wrench key into the slot in the set-screw ❶ (in the direction of the left arrow) and loosen the setscrew ❶ until the counter knife is aligned with the moving knife while lifting the setscrew ❶ in the direction of the up arrow to allow the counter knife to be pressed against the mounting base.

After you have loosened the setscrew ❶, push the adjustment screw keeping the setscrew ❷ held loosened.

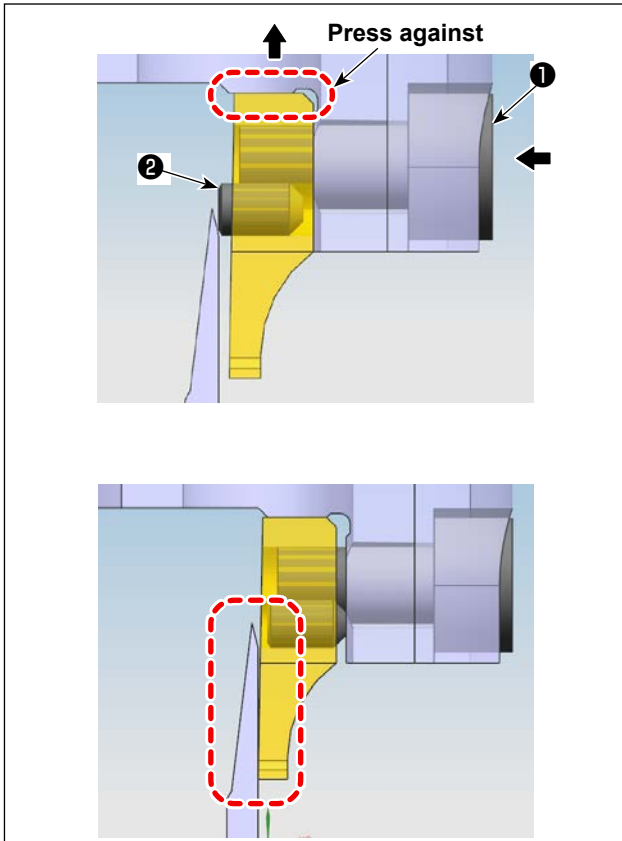

**Caution** Target knife pressure is 0 (zero). (So that the moving knife comes in slight contact with the counter knife)

After you have pushed the adjustment screw ❷, tighten the setscrew ❶.

Adjust the counter knife and the moving knife until they are aligned well with each other.

### 6-2-4-7. Cutting test

After you have adjusted the knife pressure, try to cut the material.

If the knife fails to cut the material, it will be necessary to re-adjust the knife pressure to a slightly higher value than the adjustment value given in "6-2-4-6. Adjusting the knife pressure" p.84.

**Caution** In order to ensure the service life of the moving knife and counter knife, it is recommended that a profession engineer carries out adjustment of the knife pressure so as to adjust the knife pressure to the best-suited value.

### 6-2-5. Changing the moving knife

Loosen two screws (rotary moving knife parts catalog number 53) on the moving knife. Detach the moving knife and change it with a new one. Then, tighten the aforementioned two screws. When you attach a moving knife, take care to attach it so that its bottom portion comes in contact with the moving knife rod without fail.

### 6-2-6. Adjusting the operating speed of template when the knife operates

Start the machine and proceed to the main interface. Then, click "Menu" ① . Click "Param File" ② , "Speed param" ③ , and click the "Next" ④ . Then, adjust the "Head 2 speed (mm/s)" parameter value as shown in ⑤ . When you want to adjust the related parameter(s), contact the manufacturer or the professional worker who is an expert on the related technology (The Head 2 speed has been factory-set to 40 mm/s at the time of shipment).



## 6-2-7. Usage instructions

### 6-2-7-1. Creating patterns

When you want to create a knife pattern, take care to ensure that the shortest distance of 3 mm or more is provided from the knife locus line to the seam line. Sewing patterns are created using the Layer 1, and knife patterns are created using the Layer 2.

### 6-2-7-2. Installing the sewing software

Open the exclusive rotary knife sewing software. Select the file and click it to open. Select the file you want to edit. Set a graphic of the knife you want to use to the Layer 2 (as shown in Fig. 1). Double-click on Layer 2 to open the interface (as shown in Fig. 2). Change the Head 1 with the Head 2. Then, confirm with a click on the OK button to complete the procedure.

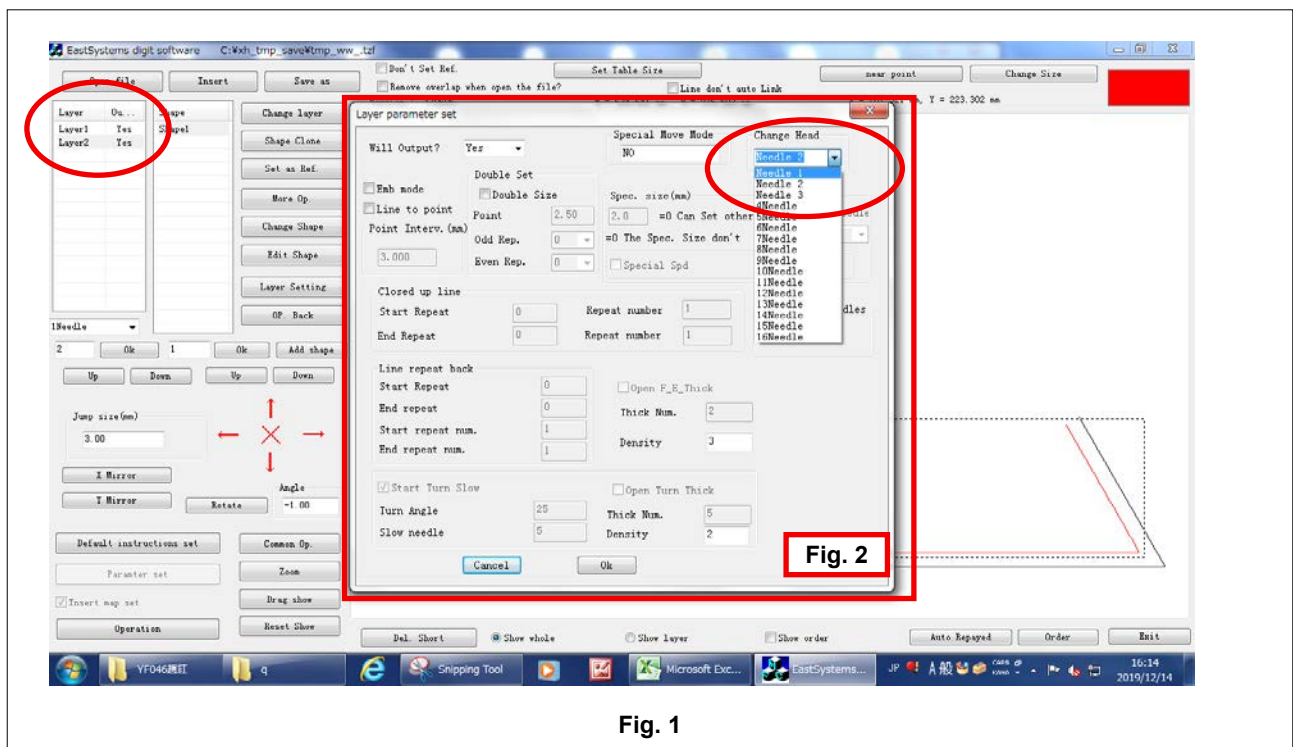
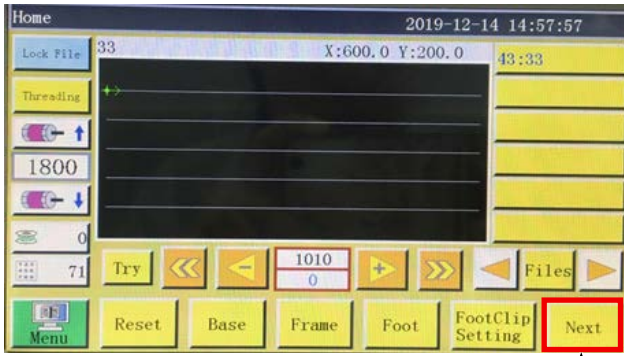

Fig. 1

### 6-2-7-3. Setting the references



1

Start the machine and proceed to the main interface. Then, click "Next" ①. Click "Move frame" ②, "Head Offset" ③, and the "Head 2 displacement". Enter "98.5" in the X-axis direction field and "54.5" in the Y-axis direction field (The head 2 position should be adjusted according to the cutting position and the displacement of sewing position. The smaller the X-axis travel amount is entered, the more the knife position is moved to the left. The smaller the Y-axis travel amount is entered, the closer the sewing position that faces to the knife position is brought to the work position).

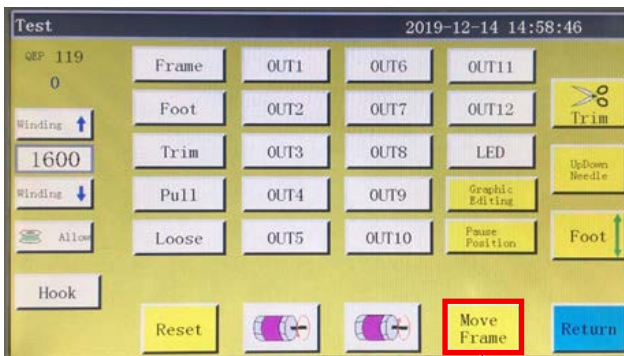

2

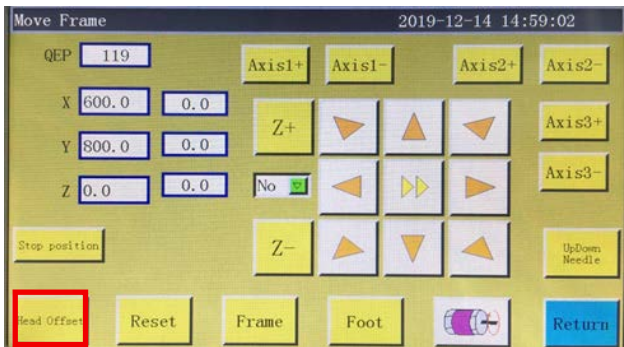

3

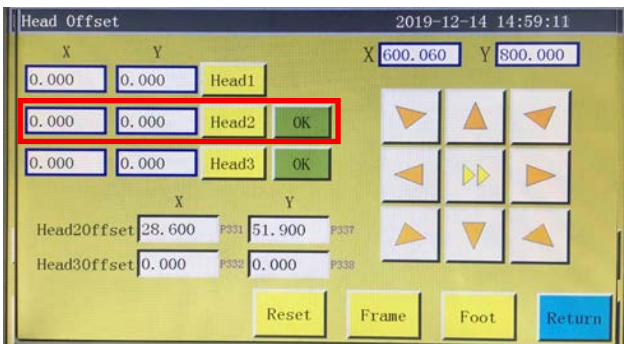

### 6-2-8. Definition of the electrical control buttons

- OUT9 Lifting / lowering of the rotary counter knife / moving knife
- OUT11 Starting the cutting operation of the rotary moving knife
- OUT12 Lifting / lowering of the clamp foot of the rotary counter knife

### 6-2-9. Function-related precautions

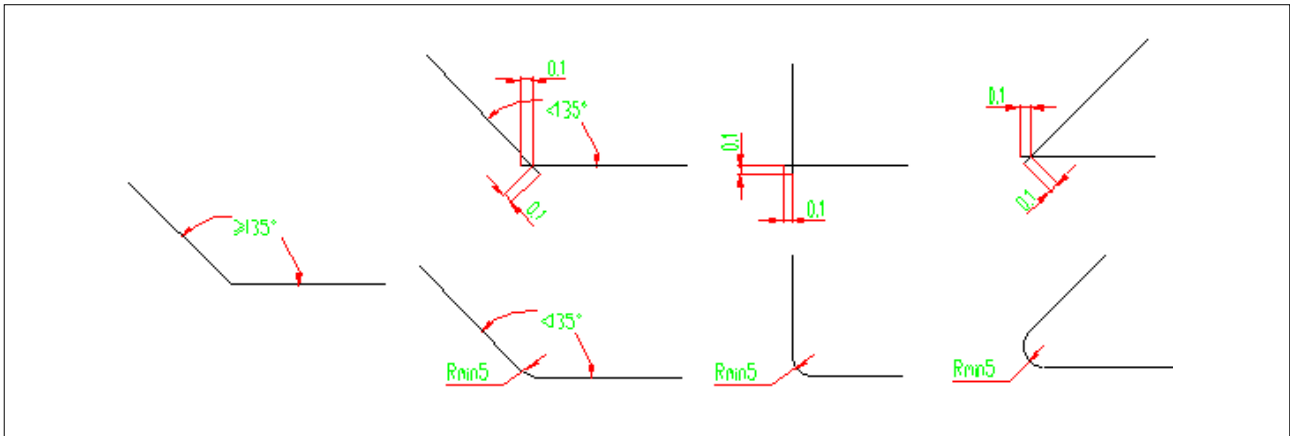

1. Do not cut a graphic that has a corner R of which is less than 5 (radius is less than 5 mm)
2. When cutting a graphic that has no corner with an excessive R, it is possible to cut it without interrupting the cutting operation at connection points provided that the angle is  $135^\circ$  or more. If the angle is less than  $135^\circ$ , the connection points intersect with each other at the position that is 0.1 mm ahead of them (as shown in the figure).
3. From the beginning to the end of cutting, cutting effect will be maximized by extending or shortening the cutting lines according to the specific effect of cutting. (Extend or shorten the length of cutting lines when cutting a graphic)